

## 1206UCF series -1206 Fast action Fuses

### Features

- Monolithic, multilayer design
- High-temperature performance
- Operating temperature range:  
-55°C to +150°C (with de-rating)
- Compatible with both wave and reflow soldering process



### Application

- LCD Displays
- Telecommunication: Cell Phones / PDA / DSL
- Data Modems
- Computers: LCD Panel / Printers/ Laptop/ Servers
- Scanners
- Handheld Electronics
- Printers

### Electrical characteristics for series

% of ampere rating	Ampere rating	Opening time at 25°C
100%	1.0-8.0A	4 Hours, Min.
250%	1.0-8.0A	Max.5 seconds.

### Standard External Dimensions

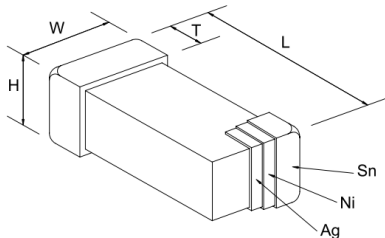

Product Dimension (mm)

Size Inch(mm)	L (mm)	W (mm)	H (mm)	T (mm)
1206(3216)	3.2±0.20	1.6±0.20	1.50 max.	0.2 min.

### Part Numbers & Characteristics

Unictron P/N	Model name	Amp. rating	Amp. code	Interrupting Ratings	Nominal Cold DCR(mΩ) <sup>1</sup>	Nominal Melting I <sup>2</sup> t (A <sup>2</sup> Sec) <sup>2</sup>
H2SFF121006100	1206UCF100A063V	1.00	H	50A 63VDC 50A 63VAC	450	0.04
H2SFF121256100	1206UCF125A063V	1.25	I		290	0.07
H2SFF121506100	1206UCF150A063V	1.50	K		220	0.10
H2SFF121756100	1206UCF175A063V	1.75	L		170	0.15
H2SFF122006100	1206UCF200A063V	2.00	N		150	0.2
H2SFF122503100	1206UCF250A032V	2.50	O	50A 32VDC 50A 32VAC	120	0.5
H2SFF123003100	1206UCF300A032V	3.00	P		83	0.9
H2SFF123503100	1206UCF350A032V	3.50	R		48	1.4
H2SFF124003100	1206UCF400A032V	4.00	S		38	2
H2SFF124503100	1206UCF450A032V	4.50	V		26	3
H2SFF125003100	1206UCF500A032V	5.00	T		23	3.5
H2SFF126003100	1206UCF600A032V	6.00	U		16	4
H2SFF127003100	1206UCF700A032V	7.00	W		14.5	7
H2SFF128003100	1206UCF800A032V	8.00	X		12	9

Notes: 1. Nominal resistance measured with < 10% rated current.  
2. Nominal Melting I<sup>2</sup>t measured at 1 msec. opening time.  
3. Black Marking Character Code.

## ■ Average Time Current Curves

### I-t CURVE

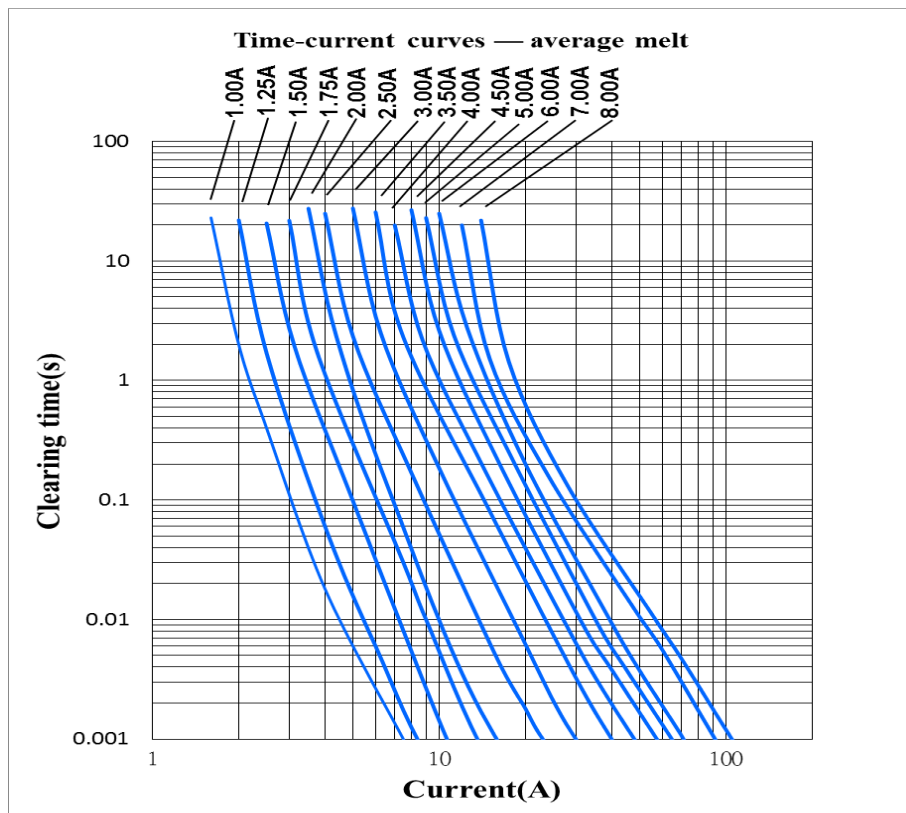

### I<sup>2</sup>t-t CURVE

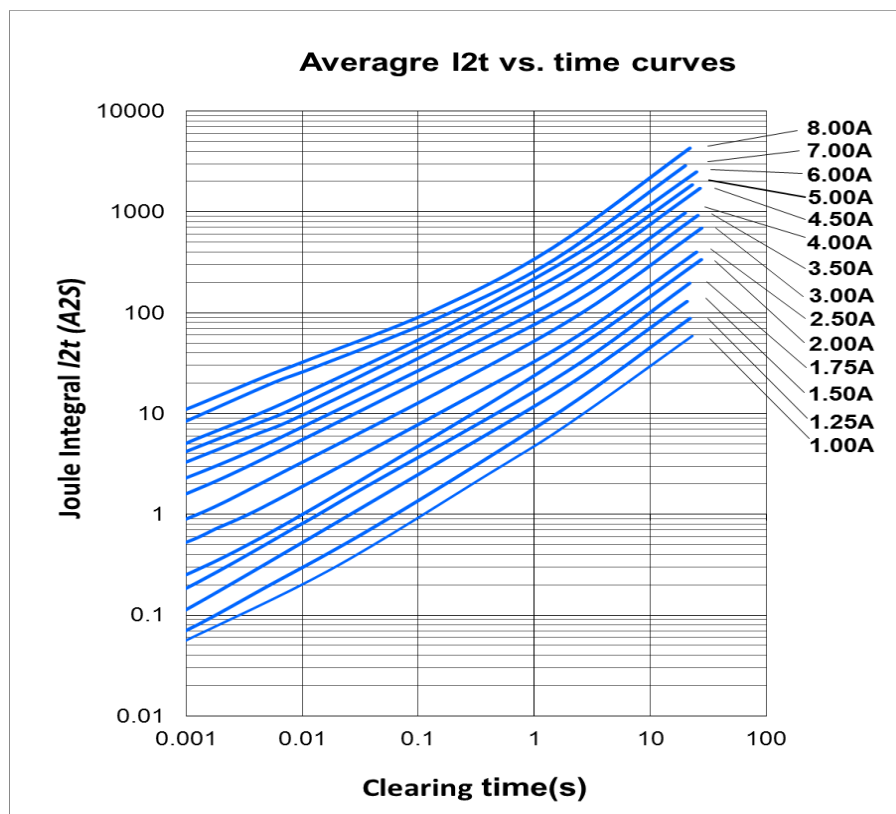

## ■ Packaging and Storage

Unictron's chip fuse are provided on tape-and-reel for use in pick-and-place machines or in bulk for special applications. Both tape-and-reel and bulk products are sealed in plastic bags with desiccant. The reel size can be 7 inches or 13 inches, depending on customers' preference.

DIMENSION (mm)	PRODUCT SIZE CODE
	1206 (3216)
E	1.75±0.1
F	3.5±0.05
P <sub>2</sub>	2.0±0.05
D	1.5+0.1/-0.0
P <sub>0</sub>	4.00±0.1
W	8.0±0.2
P	4.00±0.1
A	1.82±0.1
B	3.5±0.2
K	2.5 max.
T	0.22±0.1

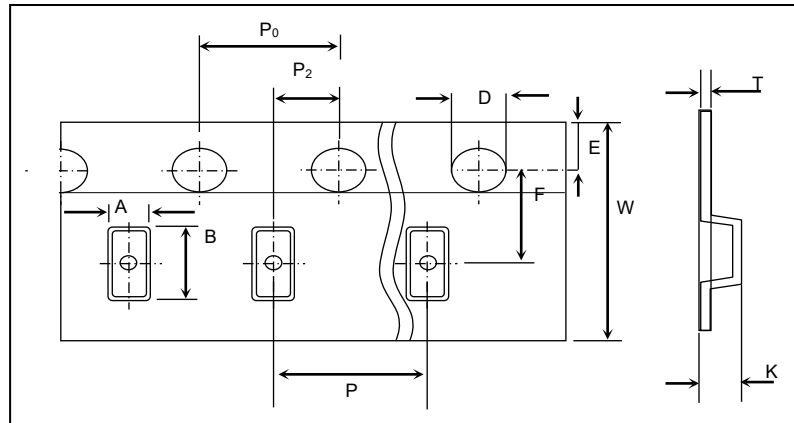

## ■ Reel specifications

DIMENSION (mm)	PRODUCT SIZE CODE
	1206(3216)
A	178±2.0
B	2+0.5/-0
C	13±0.2
D	21±0.2
W	11.4±0.5

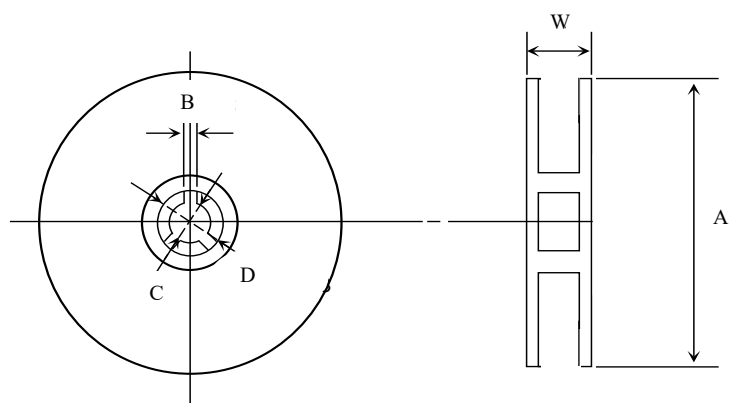

## ■ Product Identification:

**1206 UCF 100A 063V**

**(1) (2) (3) (4)**

(1) Size Code:	Standard EIA Chip Sizes
(2) Series Code:	UCF-Fast action type UCS-Slow blow type
(3) Current Rating Code:	100A-1.00A 250A-2.50A 10A0-10.0A
(4) Voltage Rating Code:	024V-24V 032V-32V 063V-63V 125V-125V

## ■ Recommended Land Pattern:

Recommended Land Patterns			
Size Inch (mm)	A (mm)	B (mm)	E (mm)
1206(3216)	1.5	3.9	1.8

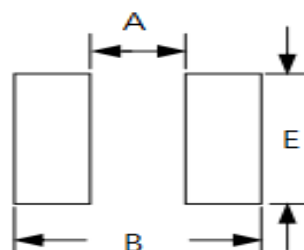

## ■ Packaging Data

Size Inch (mm)	Parts on 7 inch (178 mm) Reel
1206(3216)	3,000pcs

## ■ Storage

The maximum ambient temperature shall not exceed 40°C. Storage temperatures higher than 40°C could result in the deformation of packaging materials. The maximum relative humidity recommended for storage is 70%. High humidity with high temperature can accelerate the oxidation of the solder plating on the termination and reduce the solderability of the components. Sealed plastic bags with desiccant shall be used to reduce the oxidation of the termination and shall only be opened prior to use. The products shall not be stored in areas where harmful gases containing sulfur or chlorine are present.

## ■ Testing Condition & Requirements

No.	Item	Specification Description	Test Method
1.	<b>Resistance to solder heat</b>	DCR change: within $\pm 15\%$ without mechanical damage such as break.	Reference:MIL-STD-202, Method 210 Solder bath: $260\pm 5^{\circ}\text{C}$ ,Immersion time: $5\pm 1$ s, After test for 1hr or more, and measure the internal resistance.
2.	<b>Solder ability</b>	The surface of terminal immersed shall be minimum of 95% covered with a new coating of solder	Reference:MIL-STD-202, Method 208 $235\pm 5^{\circ}\text{C}$ solder bath, Immersion time: $2\pm 0.5$ s
3.	<b>Thermal shock</b>	DCR change: within $\pm 15\%$ without mechanical damage such as break.	Reference:MIL-STD-202, Method 107 1. Repeat 100 cycles between: $-55^{\circ}\text{C}\sim 125$ . 2.Measurement after cooling to room temperature for 24hrs.min.
4.	<b>Moisture Resistance</b>	DCR change: within $\pm 15\%$ without mechanical damage such as break.	Reference:MIL-STD-202, Method 106 Perform 10 cycles of the 24-hour heat ( $25$ to $65^{\circ}\text{C}$ ) and humidity (80 to 98%) treatments as shown below. Let sit for $24\pm 2$ hrs at room temperature, then measure.
5.	<b>Mechanical shock</b>	DCR change: within $\pm 15\%$ No mechanical damage	Refer to Unictron Standard Fall from 1 m height of the floor 10 times
6.	<b>Terminal strength</b>	No evidence of mechanical damage. DCR change : within $\pm 10\%$ without mechanical damage such as break	Reference: Unictron standard. 30 sec. hanging for 1206 (1.0kg) and 0603 (0.5KG)
7.	<b>Life</b>	No electrical "opens" during testing voltage drop change shall be less than $\pm 20\%$ of initial value.	Reference: Unictron standard. 80% Rated current ambient temperature $25\pm 5^{\circ}\text{C}$ , 1000 hours.
8.	<b>Bending</b>	No electrical "opens" during testing	Reference: Unictron standard. 2 mm bending, more than 5 seconds.

■ **Electrical Specifications:**

**Clear-Time Characteristics:** Same as specified on the Short Form Data Sheet

**Insulation Resistance after Opening:** 10,000 ohms minimum when cleared with rated voltage applied. Fuse clearing under low voltage conditions may result in lower after clearing insulation resistance values. (Note: Under normal fault conditions (low or rated voltage conditions), Unictron chip fuses provide sufficient after clearing insulation resistance values for circuit protection.)

**Carrying Capacity:** 100% rated current no open at +25°C ambient for 4 hours minimum.

**Interrupt Ratings:** Same as specified on the Short Form Data Sheet.

■ **Fuse Selection and Temperature De-rating Guideline:**

The ambient temperature affects the current carrying capacity of fuses. When a fuse is operating at a temperature higher than 25°C, the fuse shall be "de-rated".

To select a fuse from the catalog, the following rule may be followed: Catalog Fuse Current Rating = Nominal Operating Current / 0.75 / % De-rating at the maximum operating temperature.

Example:

At maximum operating temperature of 75°C, % De-rating is 84%.

The current rating for fuse selected from the catalog shall be:  $4 / 0.75 / 84\% = 6.3 \text{ A}$ . Specifications and descriptions in this literature are as accurate as known at the time of publish, but are subject to change without notice.

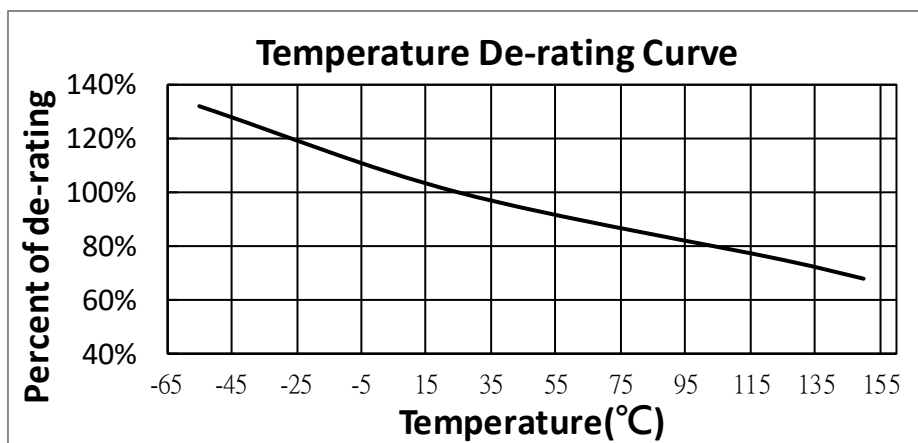

## ■ Reflow Profile Chart (Reference)

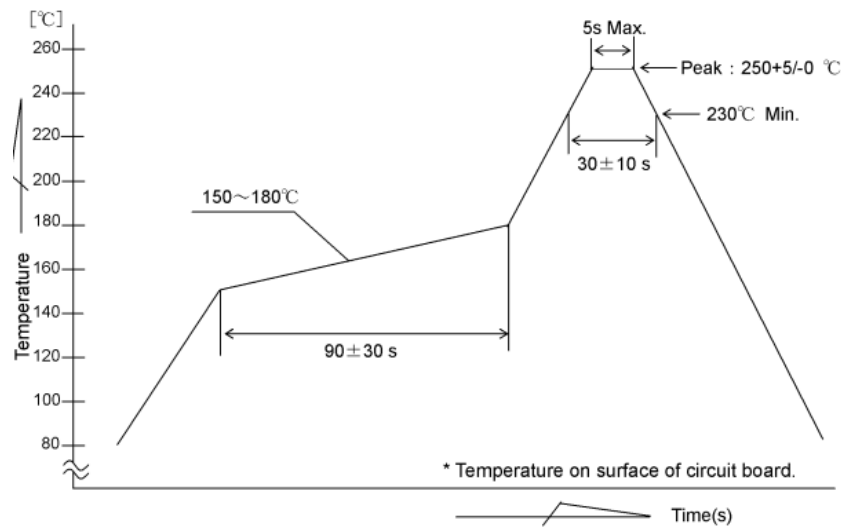

The products may be exposed to reflow soldering process of above profile up to two times.

### Recommended conditions for hand soldering:

1. Preheating: 150°C, 60s (min). Appropriate temperature (max) of soldering iron tip/soldering time (max): 280°C / 10s or 350°C / 3s Maximum temperature of soldering iron tip/soldering time : 350°C / 9s or 400°C / 8s.
2. Using hot air rework station with tip that can melt the solder on both terminations of the same time is strongly recommended, don't directly contact the chip termination with the tip of soldering iron.

### Disclaimer Notice

Specifications are subject to change without notice. UNICTRON products are designed for specific applications and should not be used for any purpose (including, without limitation, automotive, aerospace, medical, life-saving applications, or any other application which requires especially high reliability for the prevention of such defect as may directly cause damage to the third party's life, body or property) not expressly set forth in applicable UNICTRON product documentation. It is the customer's responsibility to validate that a particular product with the properties described in the product specification is suitable for use in a particular application. Warranties granted by UNICTRON shall be deemed void for products used for any purpose not expressly set forth in applicable UNICTRON product documentation. UNICTRON shall not be liable for any claims or damages arising out of products used in applications not expressly intended by UNICTRON as set forth in applicable UNICTRON product documentation. The sale and use of UNICTRON products is subject to UNICTRON terms and conditions of sale. Please refer to UNICTRON's website for updated catalog and terms and conditions of sale.