

0603UCF series -0603 Fast action Fuses

Feature

1. Monolithic, multilayer design
2. High-temperature performance
3. Operating temperature range:
-55°C to +125°C (with de-rating)
4. Halogen free
5. Lead free materials and RoHS compliant



Application

- LCD Backlight inverters
- Telecommunication: Cell Phones / PDA / DSL
- Battery packs
- Computers: LCD Panel / Printers/ Laptop/ Servers
- DVD/MP3/MP4 Players
- Bluetooth headsets
- Handheld Electronics

Electrical characteristics for series

% of ampere rating	Ampere rating	Opening time at 25°C
100%	1.0-8.0A	4 Hours, Min.
250%	1.0-8.0A	5 seconds Max.

Standard External Dimensions

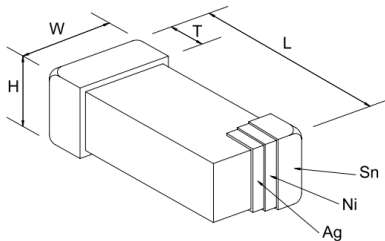

Size Inch(mm)	L (mm)	W (mm)	H (mm)	T (mm)
0603(1608)	1.6±0.15	0.8±0.15	0.8±0.20	0.2 min.

Product Dimension (mm)

Part Numbers & Characteristics

Unictron P/N	Model name	Amp rating	Amp code	Interrupting Ratings	Nominal Cold DCR(mΩ) ¹	Nominal I ² t (A ² Sec) ²
H2SFF061003100	0603UCF100A032V	1.00	H	60A 32VDC	310	0.035
H2SFF061253100	0603UCF125A032V	1.25	I		250	0.067
H2SFF061503100	0603UCF150A032V	1.50	K		165	0.10
H2SFF061753100	0603UCF175A032V	1.75	L		130	0.20
H2SFF062003100	0603UCF200A032V	2.00	N		93	0.22
H2SFF062503100	0603UCF250A032V	2.50	O		72	0.35
H2SFF063003100	0603UCF300A032V	3.00	P		48	0.48
H2SFF063503100	0603UCF350A032V	3.50	R		34	0.68
H2SFF064003100	0603UCF400A032V	4.00	S		26	1.2
H2SFF064503100	0603UCF450A032V	4.50	V		20	1.6
H2SFF065003100	0603UCF500A032V	5.00	T		16	2.5
H2SFF066003100	0603UCF600A032V	6.00	U		14	3.4
H2SFF067003100	0603UCF700A032V	7.00	W		9.5	4.5
H2SFF068003100	0603UCF800A032V	8.00	X		9	6.4

- Notes:
1. Nominal Resistance measured with < 10% rated current.
 2. Nominal Melting I²t measured at 1 msec. opening time.
 3. Black Marking Character Code.

Temperature De-rating Curve

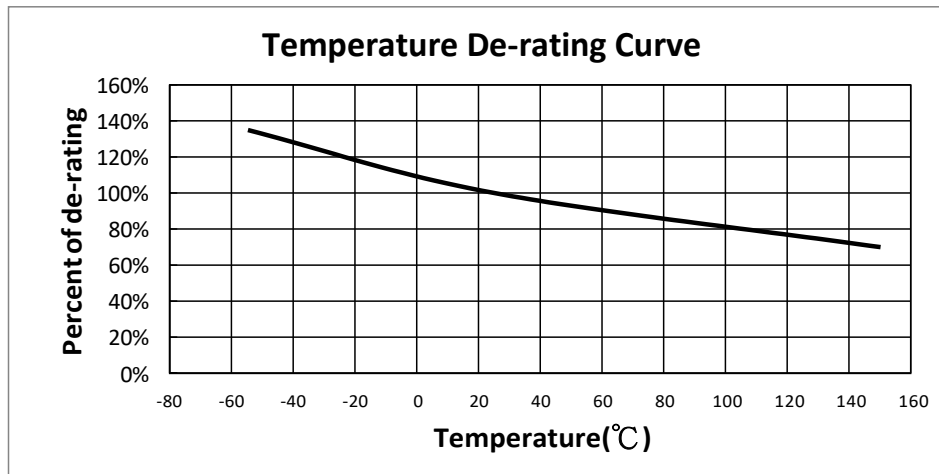

Storage Conditions:

Temperature: 5°C~35°C, Humidity:40%~75%.

Average Time Current Curves

I-t CURVE

I²t CURVE

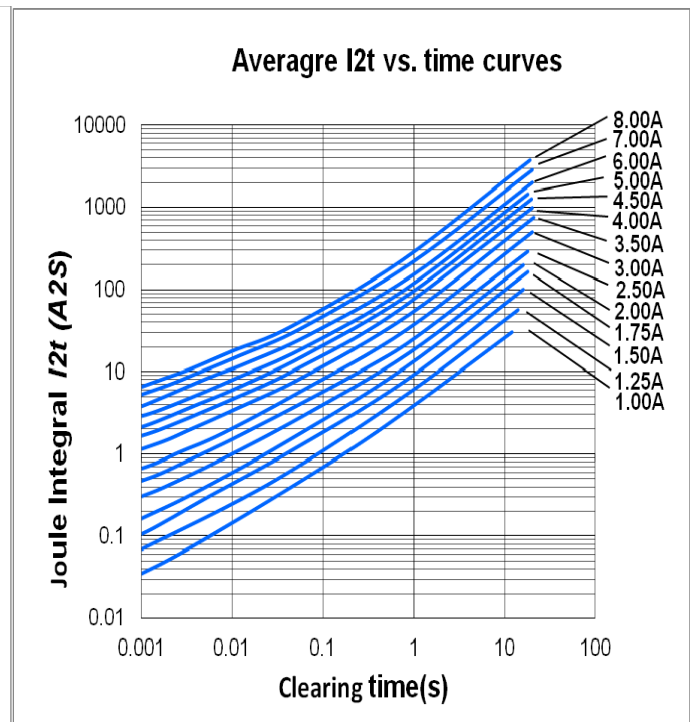
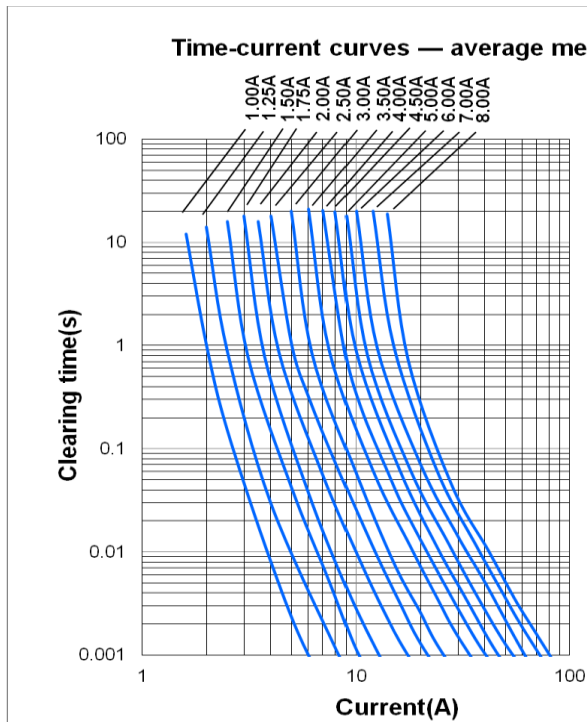

■ Packaging Specification

Code (mm)	Size
E	1.75±0.10
F	3.50±0.05
P2	2.00±0.05
D	1.50+0.1/-0
D1	1.00±0.10
P0	4.00±0.10
10P0	40.0±0.20
W	8.00±0.10
P	4.00±0.10
A0	0.94±0.10
B0	1.90±0.10
K0	0.92±0.10
t	0.22±0.05

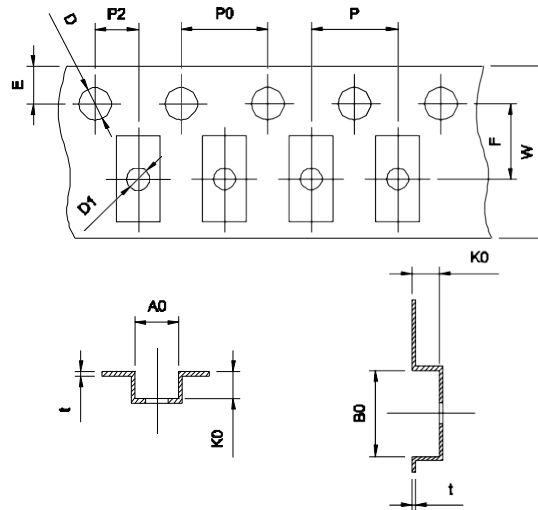

【Reel Specification】

Code (mm)	Size
A	178±1.0
B	2+0.5/-0
C	13±0.2
D	21±0.2
W	11.4±0.5

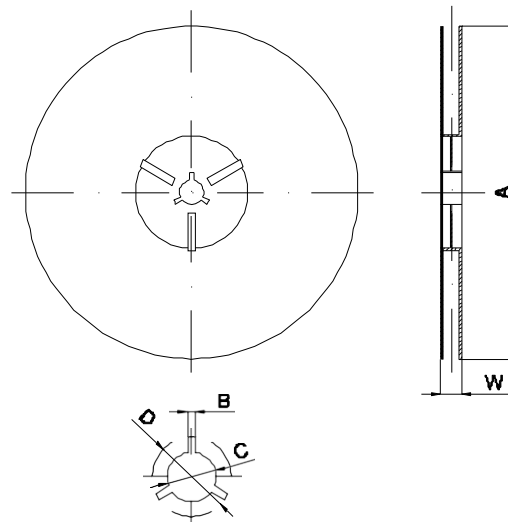

◆ **Product Identification:**

0603 UCF 100A 032V

(1) (2) (3) (4)

(1) Size Code:	Standard EIA Chip Sizes
(2) Series Code:	UCF-Fast action type UCS-Slow blow type
(3) Current Rating Code:	100A-1.00A 250A-2.50A 10A0-10.0A
(4) Voltage Rating Code:	024V-24V 032V-32V 063V-63V 125V-125V

◆ **Recommended Land Pattern:**

Recommended Land Patterns			
Size Inch (mm)	A (mm)	B (mm)	E (mm)
0603(1608)	0.8	2.2	1.0

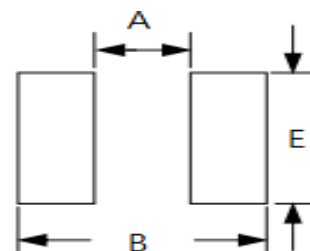

◆ **Packaging Data**

Size Inch (mm)	Parts on 7 inch (178 mm) Reel
0603(1608)	4000pcs

◆ **Storage**

The maximum ambient temperature shall not exceed 40°C. Storage temperatures higher than 40°C could result in the deformation of packaging materials. The maximum relative humidity recommended for storage is 70%. High humidity with high temperature can accelerate the oxidation of the solder plating on the termination and reduce the solderability of the components. Sealed plastic bags with desiccant shall be used to reduce the oxidation of the termination and shall only be opened prior to use. The products shall not be stored in areas where harmful gases containing sulfur or chlorine are present.

◆ Testing Condition & Requirements

No.	Item	Specification Description	Test Method
1.	Resistance to solder heat	DCR change: within $\pm 15\%$ without mechanical damage such as break.	Reference: MIL-STD-202, Method 210 Solder bath: $260 \pm 5^\circ\text{C}$, Immersion time: 5 ± 1 s, After test for 1hr or more, and measure the internal resistance.
2.	Solder ability	The surface of terminal immersed shall be minimum of 95% covered with a new coating of solder	Reference: MIL-STD-202, Method 208 $235 \pm 5^\circ\text{C}$ solder bath, Immersion time: 2 ± 0.5 s
3.	Thermal shock	DCR change: within $\pm 15\%$ without mechanical damage such as break.	Reference: MIL-STD-202, Method 107 1. Repeat 100 cycles between: $-55^\circ\text{C} \sim 125^\circ\text{C}$. 2. Measurement after cooling to room temperature for 24hrs.min.
4.	Moisture Resistance	DCR change: within $\pm 15\%$ without mechanical damage such as break.	Reference: MIL-STD-202, Method 106 Perform 10 cycles of the 24-hour heat (25 to 65°C) and humidity (80 to 98%) treatments as shown below. Let sit for 24 ± 2 hrs at room temperature, then measure.
5.	Mechanical shock	DCR change: within $\pm 15\%$ No mechanical damage	Refer to Unictron Standard Fall from 1 m height of the floor 10 times
6.	Terminal strength	No evidence of mechanical damage. DCR change : within $\pm 10\%$ without mechanical damage such as break	Reference: Unictron standard. 30 sec. hanging for 1206 (1.0kg) and 0603 (0.5KG)
7.	Life	No electrical "opens" during testing voltage drop change shall be less than $\pm 20\%$ of initial value.	Reference: Unictron standard. 80% Rated current ambient temperature $25 \pm 5^\circ\text{C}$, 1000 hours.
8.	Bending	No electrical "opens" during testing	Reference: Unictron standard. 2 mm bending, more than 5 seconds.

◆ Electrical Specifications:

Clear-Time Characteristics: Same as specified on the Short Form Data Sheet

Insulation Resistance after Opening: 10,000 ohms minimum when cleared with rated voltage applied. Fuse clearing under low voltage conditions may result in lower after clearing insulation resistance values. (Note: Under normal fault conditions (low or rated voltage conditions), Unictron chip fuses provide sufficient after clearing insulation resistance values for circuit protection.)

Carrying Capacity: 100% rated current no open at +25°C ambient for 4 hours minimum.

Interrupt Ratings: Same as specified on the Short Form Data Sheet.

◆ Fuse Selection and Temperature De-rating Guideline:

The ambient temperature affects the current carrying capacity of fuses. When a fuse is operating at a temperature higher than 25°C, the fuse shall be "de-rated".

To select a fuse from the catalog, the following rule may be followed: Catalog Fuse Current Rating = Nominal Operating Current / 0.75 / % De-rating at the maximum operating temperature.

Example:

At maximum operating temperature of 75°C, % De-rating is 84%.

The current rating for fuse selected from the catalog shall be: $4 / 0.75 / 84\% = 6.3$ A. Specifications and descriptions in this literature are as accurate as known at the time of publish, but are subject to change without notice.

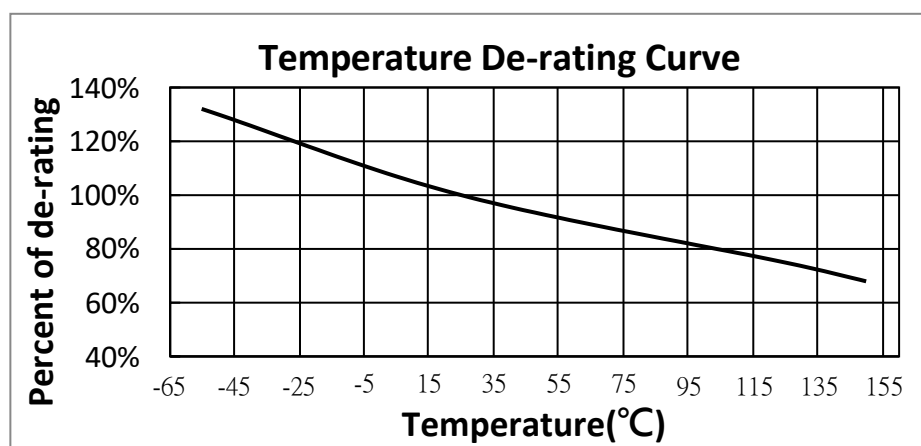

◆ Reflow Profile Chart (Reference)

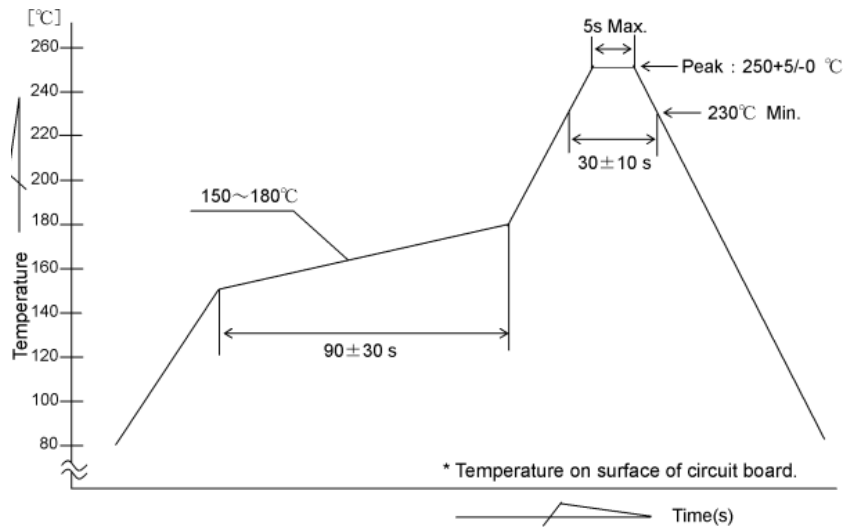

The products may be exposed to reflow soldering process of above profile up to two times.

Recommended conditions for hand soldering:

1. Preheating: 150°C, 60s (min). Appropriate temperature (max) of soldering iron tip/soldering time (max): 280°C/ 10s or 350°C/ 3s Maximum temperature of soldering iron tip/soldering time : 350°C/ 9s or 400°C/ 8s.
2. Using hot air rework station with tip that can melt the solder on both terminations of the same time is strongly recommended, don't directly contact the chip termination with the tip of soldering iron.

Disclaimer Notice

Specifications are subject to change without notice. UNICTRON products are designed for specific applications and should not be used for any purpose (including, without limitation, automotive, aerospace, medical, life-saving applications, or any other application which requires especially high reliability for the prevention of such defect as may directly cause damage to the third party's life, body or property) not expressly set forth in applicable UNICTRON product documentation. It is the customer's responsibility to validate that a particular product with the properties described in the product specification is suitable for use in a particular application. Warranties granted by UNICTRON shall be deemed void for products used for any purpose not expressly set forth in applicable UNICTRON product documentation. UNICTRON shall not be liable for any claims or damages arising out of products used in applications not expressly intended by UNICTRON as set forth in applicable UNICTRON product documentation. The sale and use of UNICTRON products is subject to UNICTRON terms and conditions of sale. Please refer to UNICTRON's website for updated catalog and terms and conditions of sale.