

Device Ratings and Characteristics														
Part No.	Device Marking	Maximum Allowable Voltage		Varistor Voltage (@1mA)			Clamping Voltage @ Test Current (@8/20µs)		Maximum Energy (@10/1000µs)	Maximum Peak Current (@8/20µs)	Rated Power (W)	Typical Capacitance (@1KHz) (pF)	UL 1449 4th, In @8/20us (KA)	Related Standards Symbol
		ACrms(V)	DC(V)	Vn(Vdc)	Min.	Max.	Vc(V)	Ip(A)	(J)	(A)				
CNR-20V201K	20V201K	130	170	200	180	220	340	100	140	10000	1	1700	5	◇
CNR-20V221K	20V221K	140	180	220	198	242	360	100	155	10000	1	1600		◇
CNR-20V241K	20V241K	150	200	240	216	264	395	100	170	10000	1	1500		◇
CNR-20V271K	20V271K	175	225	270	243	297	455	100	190	10000	1	1300		◇
CNR-20V301K	20V301K	195	250	300	270	330	500	100	215	10000	1	1200		◇
CNR-20V331K	20V331K	215	275	330	297	363	550	100	228	10000	1	1100		◇
CNR-20V361K	20V361K	230	300	360	324	396	595	100	255	10000	1	1100		◇
CNR-20V391K	20V391K	250	320	390	351	429	650	100	275	10000	1	1100		◇
CNR-20V431K	20V431K	275	350	430	387	473	710	100	303	10000	1	1000		◇
CNR-20V471K	20V471K	300	385	470	423	517	775	100	350	10000	1	900		◇
CNR-20V511K	20V511K	320	410	510	459	561	845	100	382	10000	1	800		◇
CNR-20V561K	20V561K	350	460	560	504	616	915	100	382	10000	1	750		□
CNR-20V621K	20V621K	395	510	620	558	682	1020	100	400	10000	1	570		□
CNR-20V681K	20V681K	420	560	680	612	748	1120	100	420	10000	1	550		□
CNR-20V751K	20V751K	465	615	750	675	825	1235	100	420	10000	1	530		□
CNR-20V781K	20V781K	485	640	780	702	858	1290	100	440	10000	1	500		□
CNR-20V821K	20V821K	510	670	820	738	902	1355	100	460	10000	1	500		□
CNR-20V911K	20V911K	550	745	910	819	1001	1500	100	510	10000	1	480		□
CNR-20V102K	20V102K	625	825	1000	900	1100	1650	100	565	10000	1	460		□
CNR-20V112K	20V112K	680	895	1100	990	1210	1815	100	620	10000	1	400		□

Related Standards

Symbols	◇				□		
Approval							

Reliability

Characteristics	Standard	Test Conditions	Specifications
Robustness of terminations	IEC 60068-2-21 Test Ua1	F = 10 N (d ≤ 0.8 mm) ,F = 20 N (d = 1 mm)	$\Delta V/V \leq \pm 10\%$ No visible damage
Solderability	IEC 60068-2-20 Test Ta (Method 1)	T = 235±5 °C, d = 2±0.5s	Approximately ≥ 95%
Resistance to soldering heat	IEC 60068-2-20 Test Tb (Method 1A)	T = 260±5 °C, d = 10±1s	$\Delta V/V \leq \pm 10\%$ No visible damage
Shock	IEC 60068-2-27 Test Ea	Pulse shape: half-sine. a = 490 m/s ² , d = 11ms. N = 6 x 3 shocks	$\Delta V/V \leq \pm 10\%$ No visible damage
Vibration	IEC 60068-2-6 Test Fc Method B4	Frequency range: 10 Hz to 55 Hz ,a = 0.75 mm or 98 m/s ² (whichever is the less), d = 3x2 h	$\Delta V/V \leq \pm 10\%$ No visible damage
Needle flame test	IEC 60695-11-5	Severity: Vertical 10 s	Duration of burning: 5 s max.
Voltage under pulse condition	IEC 61051-2	At class current	As specified in specification
Voltage proof	IEC 61051-2	Metal balls method (4.8.1.2) 2500 V, 60 s	As specified in specification
Pulse current - 8/20 μs	IEC 61051-2	8/20 μs, 10 times, I peak=0.25*Imax	$\Delta V/V \leq \pm 10\%$ No visible damage
Pulse current - 10/1000 μs	IEC 61051-2	10/1000 μs, 10 times, Ipeak = 0.0075* Imax	$\Delta V/V \leq \pm 10\%$ No visible damage
Combination pulse	IEC 60950-1:2013 Annex Q	Additional test: 10 pulses (combination pulse 6KV/3KA), in one direction, 1 per min	$\Delta V/V \leq \pm 10\%$ No visible damage U ≤ 1.1 Uinitial Voltage proof:No breakdown or flashover
Rapid change of temperature	IEC 60068-2-14 Test Na	N = 5 cycles, d = 30 min , θA = -40±3°C, θB = 85±2°C	$\Delta V/V \leq \pm 10\%$ No visible damage
Climatic sequence	IEC 60068-2-2 Test Ba IEC 60068-2-30 Test Db IEC 60068-2-1 Test Aa IEC 60068-2-30 Test Db	Dry heat, Test Ba:16±2h, T = 85±2°C Damp heat, Test Db first cycle :24h, T = 55±2°C Cold, Test Aa :2h, T = -40±3°C Damp heat Test Ba remaining cycles:5 cycle	$\Delta V/V \leq \pm 10\%$ No visible damage RISO ≥ 100MΩ Voltage proof:No breakdown or flashover
Endurance at upper category temperature	IEC 61051-1 (4.21)	T:max temperature as specified , Duration: 1000 h, Voltage: max. a.c. voltage	$\Delta V/V \leq \pm 10\%$ No visible damage R ≥ 1000MΩ U ≤ 1,1 Uinitial

Reliability

Characteristics	Standard	Test Conditions	Specifications
Damp heat (Steady state)	IEC 60068-2-78 Test Ca	T = 40±2°C, RH = 93(+2/-3)%, 56d , 4 specimens:No voltage applied , Other 4 specimens:Applied voltage: 10% of the max. d.c. voltage	$\Delta V/V \leq \pm 10\%$ RISO $\geq 100M\Omega$
Maximum Peak Current	Specification Standard	$I_{max}, 8/20 \mu s, 1 \text{ time}$ $\frac{V_{max} \text{ at } 85^\circ C - V_{max} \text{ at } 25^\circ C}{V_{max} \text{ at } 25^\circ C} \times \frac{1}{60} \times 100 (\%/C)$	$-0.05 \leq TC \leq 0.05 (\%/C)$
Nominal Discharge Current Test	UL1449 4th	Nominal Discharge Current (In), 8/20 μs , 15 times	$\Delta V/V \leq \pm 10\%$ No visible damage
Varistor Voltage Temp. Coefficient	Specification Standard	V1mA at -40°C, 85°C, 25°C	$\Delta V/V \leq \pm 10\%$ No visible damage
High Temperature Storage	IEC60068-2-2	1000h, T = 85±2°C	$\Delta V/V \leq \pm 10\%$ No visible damage
Max. Energy	Specification Standard	10/1000 μs , 1 tmes, Max. Energy	$\Delta V/V \leq \pm 10\%$ No visible damage
Operating duty cycle test *	UL 1449	6 kV/3 kA combination wave surges, phase angle of 90 (+0, -15) degrees, npositive polarity 8 times, negative polarity 7 times, interval of 60s.	$\Delta V/V \leq \pm 10\%$ No visible damage
Surge Immunity Test*	IEC 61000-4-5	4kV/2kA combination wave surges, phase angle of 90 (+0, -15) degrees, npositive polarity 20times, negative polarity 20times, interval of 60s.	$\Delta V/V \leq \pm 10\%$ No visible damage

* (According to customer requirements to meet the test items)

Impulse Life Time Rating Curves

CNR-20V201K to CNR-20V112K

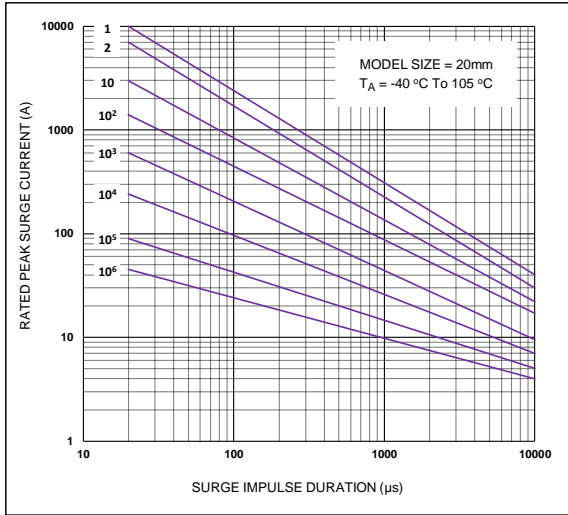

CNR-20V201K to CNR-20V511K V-I Curves

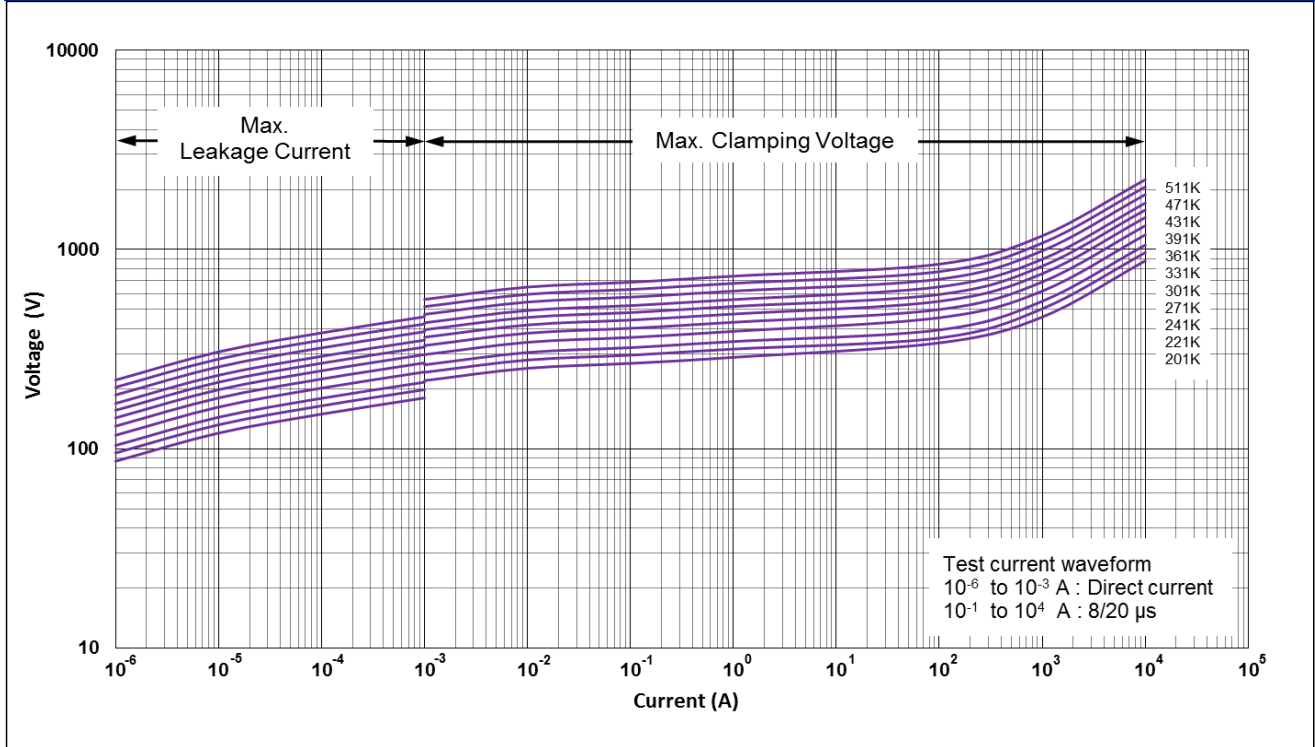

CNR-20V561K to CNR-20V112K V-I Curves

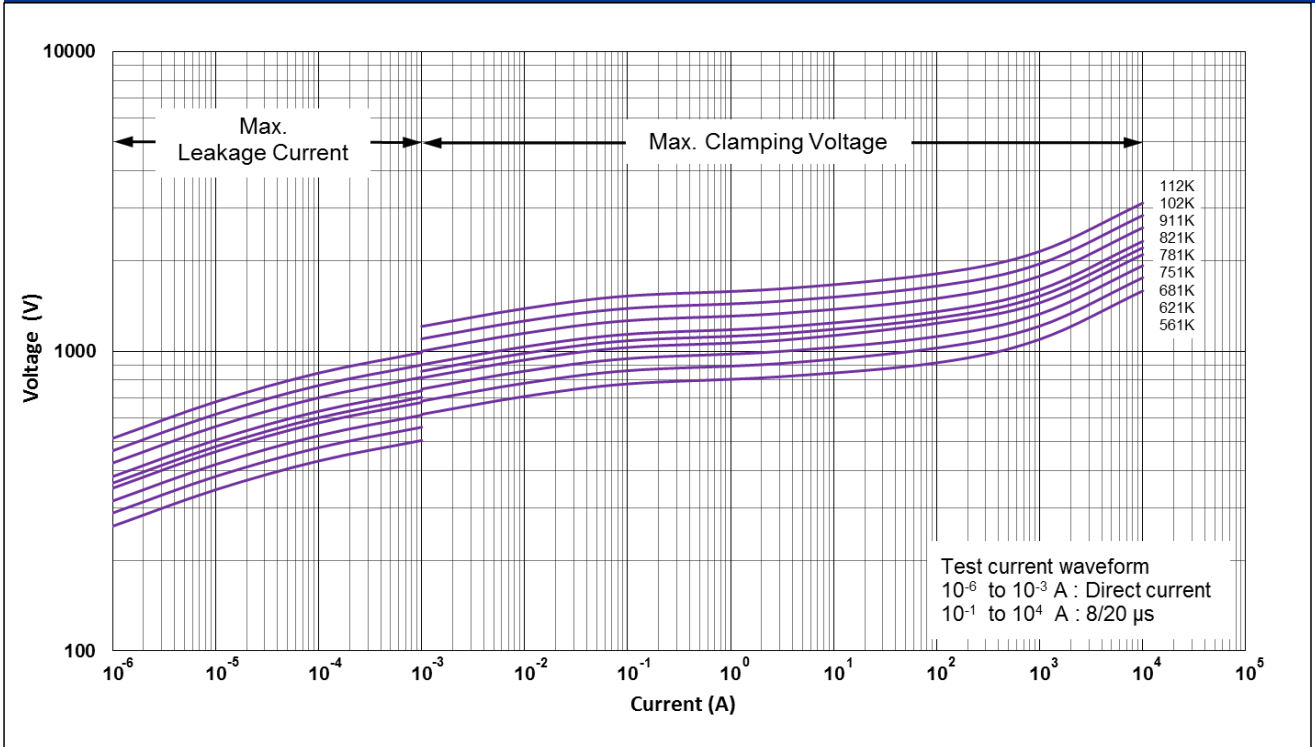

Power Derating Curve

Should transients occur in rapid succession, the average power dissipation is the energy (watt-seconds) per pulse times the number of pulses per second. The power so developed must be with the specifications shown on the Device Ratings and Specifications Table for the specific device. The operating values of a MOV need to be derated at high temperatures as shown above. Because varistors only dissipate a relatively small amount of average power they are not suitable for repetitive applications that involve substantial amounts of average power dissipation.

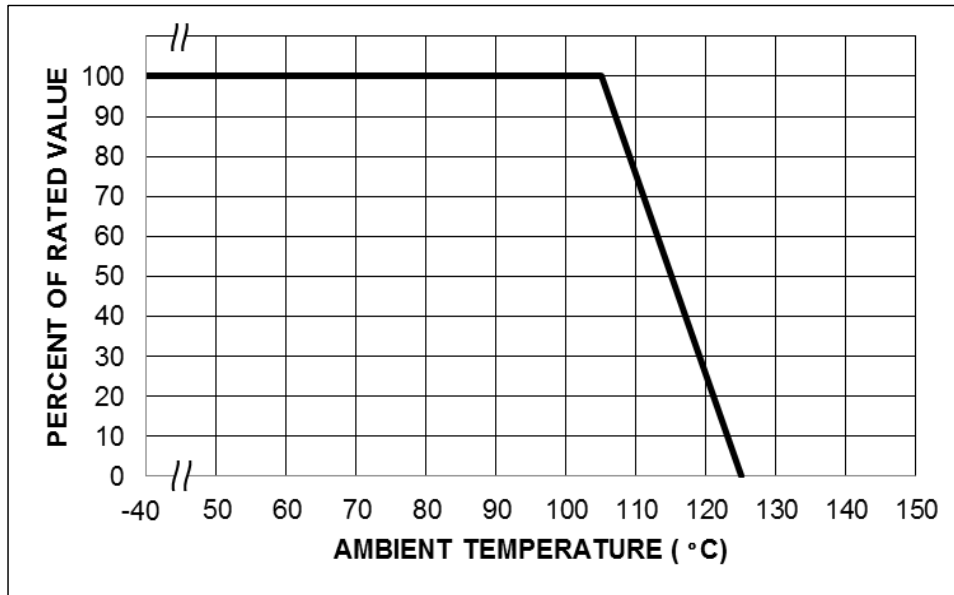

Surge Current Standard Waveform

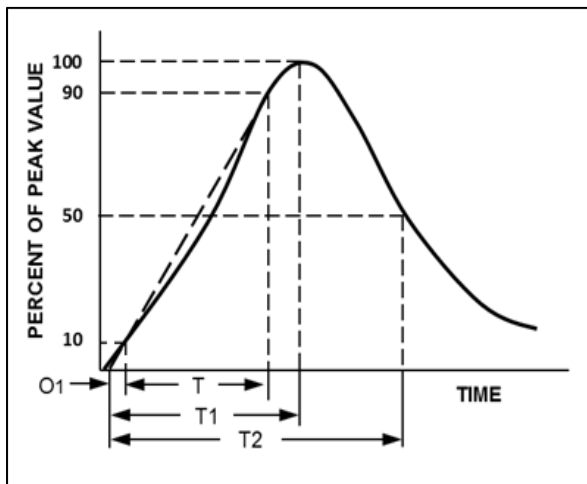

O1 = Virtual Origin of Wave
 T = Time from 10% to 90% of Peak
 T1 = Rise Time = 1.25 x T
 T2 = Decay Time
 Example - For an 8/20 μs Current Waveform:
 8μs = T1 = Rise Time
 20μs = T2 = Decay Time

Product Dimensions

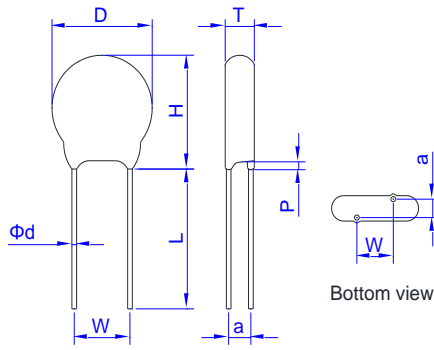

Fig 1. Straight Lead

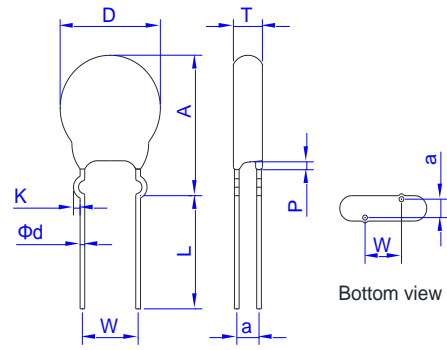

Fig 2. Outside Kink Lead

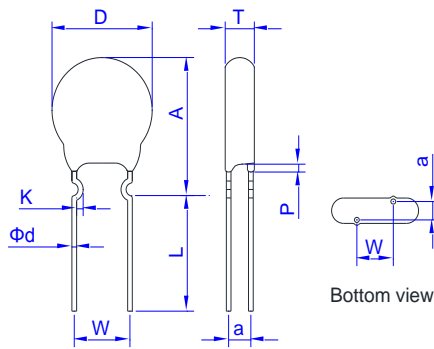

Fig 3. Inside Kink Lead

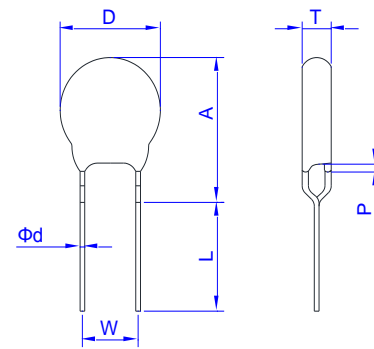

Fig 4. In Line Kink Lead

Dimension Table

Unit:mm

Symbol	Model size	05V		07V		10V		14V		18V		20V	
		Min.	Max.	Min.	Max.	Min.	Max.	Min.	Max.	Min.	Max.	Min.	Max.
D		5.5	7.5	7.5	9.0	10.5	14.0	13.5	17.5	18.5	23.0	19.5	25.0
H		-	10.0	-	12.0	-	17.0	-	20.5	-	26.0	-	28.0
W		4.0	6.0	4.0	6.0	6.5	8.5	6.5	8.5	6.5	8.5	9.0	11.0
∅ d		0.55	0.65	0.55	0.65	0.75	0.85	0.75	0.85	0.75	0.85	0.95	1.05
P(max.)		3.0											
L(min)		25.0											
K(Kink Lead)		0.8	1.6	0.8	1.6	1.0	1.8	1.0	1.8	1.0	1.8	1.0	1.8
A(max.)	180K-271K	-	13.0	-	15.0	-	19.5	-	22.5	-	26.5	-	30.0
	>271K	-	13.0	-	15.0	-	20.5	-	23.5	-	27.0	-	31.0
T		See Tmax table											

* Short Cut Lead type TTX the lead length (L) can 3.0~15mm (except 20V<10mm), see Ordering Note.

* * a value see T max. table

T max. Table								Unit:mm							
Model	05V	07V	10V	14V	18V	20V	a(±1.0)	Model	05V	07V	10V	14V	18V	20V	a(±1.0)
201K	3.3	3.5	3.9	4.0	4.2	4.3	1.5	511K	4.8	5.0	5.3	5.4	5.6	5.7	2.6
221K	3.4	3.6	4.0	4.1	4.3	4.4	1.6	561K	5	5.2	5.5	5.6	5.8	5.9	2.8
241K	3.5	3.7	4.1	4.2	4.4	4.5	1.7	621K	5.3	5.5	5.7	5.8	6.0	6.1	3.1
271K	3.7	3.9	4.2	4.3	4.5	4.6	1.8	681K	5.4	5.6	5.8	5.9	6.1	6.2	3.3
301K	3.9	4.1	4.3	4.4	4.6	4.7	1.9	751K	5.6	5.8	6.0	6.1	6.3	6.4	3.6
331K	4	4.2	4.5	4.6	4.8	4.9	2.0	781K	-	6.0	6.3	6.4	6.6	6.7	3.8
361K	4.1	4.3	4.7	4.8	5.0	5.1	2.1	821K	-	6.3	6.5	6.6	6.8	6.9	4.0
391K	4.2	4.4	4.8	4.9	5.1	5.2	2.3	911K	-	-	6.6	6.7	6.9	7.0	4.3
431K	4.4	4.6	5.0	5.1	5.3	5.4	2.4	102K	-	-	7.0	7.1	7.3	7.4	4.6
471K	4.6	4.8	5.2	5.3	5.5	5.6	2.5	112K	-	-	7.4	7.5	7.7	7.9	5.2

Tape and Reel Specifications

● Radial devices on tape are supplied with straight leads, kinked leads or in-line leads

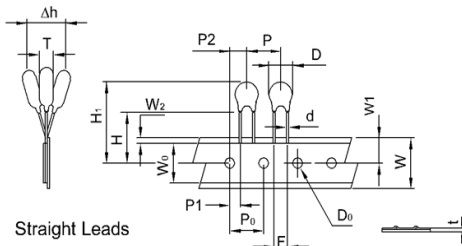
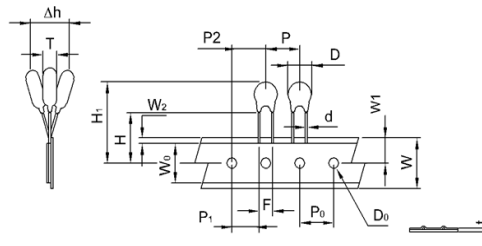
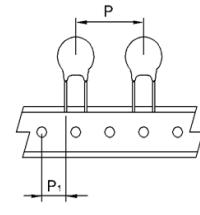
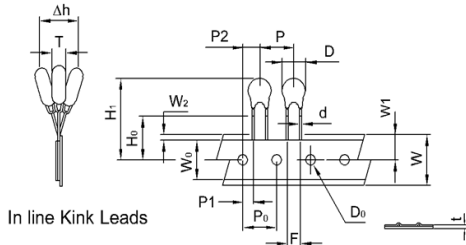
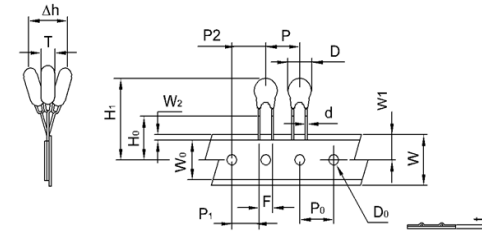
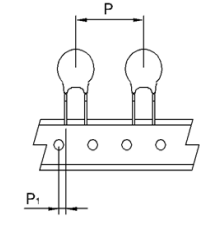
Figure: A

Figure: B

Figure: C

Figure: D

Figure: E

Figure: F

Symbol	Description	Model Size					
		05V	07V	10V	10V	14V	14V
P	Pitch of Component	12.7±1.0	12.7±1.0	12.7±1.0	15.0±1.0	25.4±1.0	30.0±1.0
P ₀	Feed Hole Pitch	12.7±0.2	12.7±0.2	12.7±0.2	15.0±0.2	12.7±0.2	15.0±0.2
P ₁	Feed Hole Center to Pitch	3.85±0.7	3.85±0.7	3.85±0.7	3.75±0.7	8.95±0.7	3.75±0.7
P ₂	Hole Center to Component Center	6.35±0.7	6.35±0.7	6.35±0.7	7.5±0.7	12.7±0.7	7.5±0.7
F	Lead to Lead Distance	5.0±0.8	5.0±0.8	7.5±0.8	7.5±0.8	7.5±0.8	7.5±0.8
△h	Component Alignment	2.0max	2.0max	2.0max	2.0max	2.0max	2.0max
W	Tape Width	18.0+1.0	18.0+1.0	18.0+1.0	18.0+1.0	18.0+1.0	18.0+1.0
		18.0-0.5	18.0-0.5	18.0-0.5	18.0-0.5	18.0-0.5	18.0-0.5
W ₀	Hold Down Tape Width	5.0 Min.	5.0 Min.	5.0 Min.	5.0 Min.	5.0 Min.	5.0 Min.
W ₁	Hole Position	9.0+0.75	9.0+0.75	9.0+0.75	9.0+0.75	9.0+0.75	9.0+0.75
		9.0-0.5	9.0-0.5	9.0-0.5	9.0-0.5	9.0-0.5	9.0-0.5
W ₂	Hold Down Tape Position	3.0 Max	3.0 Max	3.0 Max	3.0 Max	3.0 Max	3.0 Max
H	Height from Tape Center to Component Base	18.0+2.0	18.0+2.0	18.0+2.0	18.0+2.0	18.0+2.0	18.0+2.0
		18.0-0.0	18.0-0.0	18.0-0.0	18.0-0.0	18.0-0.0	18.0-0.0
H ₀	Seating Plane Height	16.0±0.5	16.0±0.5	16.0±0.5	16.0±0.5	16.0±0.5	16.0±0.5
H ₁	Component Height	32.0 Max.	32.0 Max.	36.0 Max.	36.0 Max.	40.0 Max.	40.0 Max.
D ₀	Feed Hole Diameter	4.0±0.2	4.0±0.2	4.0±0.2	4.0±0.2	4.0±0.2	4.0±0.2
t	Total Tape Thickness	0.7±0.2	0.7±0.2	0.7±0.2	0.7±0.2	0.7±0.2	0.7±0.2
L	Leagth Clipped Lead	11.0 Max	11.0 Max	11.0 Max	11.0 Max	11.0 Max	11.0 Max
Figure		A, D	A, D	B, E	A, D	C	F

Tape and Reel Specifications

● Radial devices on tape are supplied with straight leads, kinked leads or in-line leads

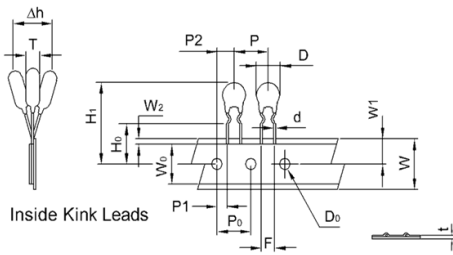

Figure: A

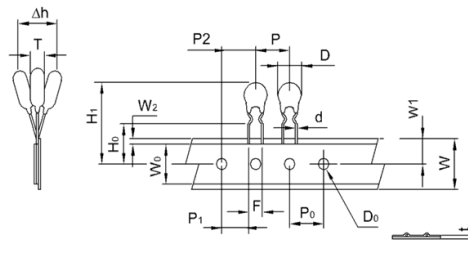

Figure: B

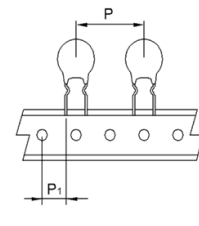

Figure: C

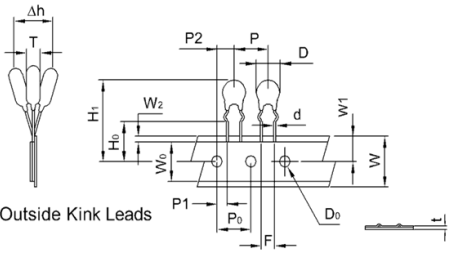

Figure: D

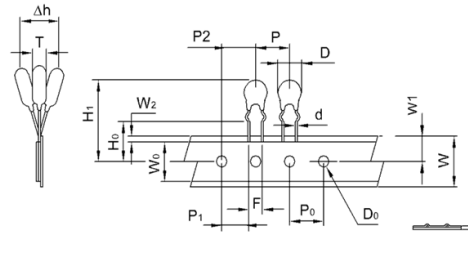

Figure: E

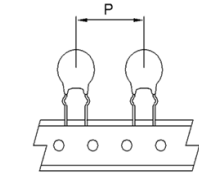

Figure: F

Symbol	Description	Model Size					
		05V	07V	10V	10V	14V	14V
P	Pitch of Component	12.7±1.0	12.7±1.0	12.7±1.0	15.0±1.0	25.4±1.0	30.0±1.0
P ₀	Feed Hole Pitch	12.7±0.2	12.7±0.2	12.7±0.2	15.0±0.2	12.7±0.2	15.0±0.2
P ₁	Feed Hole Center to Pitch	3.85±0.7	3.85±0.7	3.85±0.7	3.75±0.7	8.95±0.7	3.75±0.7
P ₂	Hole Center to Component Center	6.35±0.7	6.35±0.7	6.35±0.7	7.5±0.7	12.7±0.7	7.5±0.7
F	Lead to Lead Distance	5.0±0.8	5.0±0.8	7.5±0.8	7.5±0.8	7.5±0.8	7.5±0.8
Δh	Component Alignment	2.0max	2.0max	2.0max	2.0max	2.0max	2.0max
W	Tape Width	18.0+1.0	18.0+1.0	18.0+1.0	18.0+1.0	18.0+1.0	18.0+1.0
		18.0-0.5	18.0-0.5	18.0-0.5	18.0-0.5	18.0-0.5	18.0-0.5
W ₀	Hold Down Tape Width	5.0 Min.	5.0 Min.	5.0 Min.	5.0 Min.	5.0 Min.	5.0 Min.
W ₁	Hole Position	9.0+0.75	9.0+0.75	9.0+0.75	9.0+0.75	9.0+0.75	9.0+0.75
		9.0-0.5	9.0-0.5	9.0-0.5	9.0-0.5	9.0-0.5	9.0-0.5
W ₂	Hold Down Tape Position	3.0 Max	3.0 Max	3.0 Max	3.0 Max	3.0 Max	3.0 Max
H	Height from Tape Center to Component Base	18.0+2.0	18.0+2.0	18.0+2.0	18.0+2.0	18.0+2.0	18.0+2.0
		18.0-0.0	18.0-0.0	18.0-0.0	18.0-0.0	18.0-0.0	18.0-0.0
H ₀	Seating Plane Height	16.0±0.5	16.0±0.5	16.0±0.5	16.0±0.5	16.0±0.5	16.0±0.5
H ₁	Component Height	32.0 Max.	32.0 Max.	36.0 Max.	36.0 Max.	40.0 Max.	40.0 Max.
D ₀	Feed Hole Diameter	4.0±0.2	4.0±0.2	4.0±0.2	4.0±0.2	4.0±0.2	4.0±0.2
t	Total Tape Thickness	0.7±0.2	0.7±0.2	0.7±0.2	0.7±0.2	0.7±0.2	0.7±0.2
L	Leagth Clipped Lead	11.0 Max	11.0 Max	11.0 Max	11.0 Max	11.0 Max	11.0 Max
Figure		A, D	A, D	B, E	A, D	C	F

Packing information

Bulk packing

Series	Straight Lead Type Quantity(pcs/bag)	Cut Lead Type Quantity(pcs/bag)	Kink Type Quantity(pcs/bag)
CNR-05V	1000	1000	1000
CNR-07V	1000	1000	1000
CNR-10V	500	500	500
CNR-14V	500	500	500
CNR-18V	500	500	500
CNR-20V	250	250	250

Tape & Reel product packing

Series	A (mm)	Quantity (pcs/reel)
CNR-05V(180K~391K)-TRXX	43	2000
CNR-05V(431K~751K)-TRXX		1500
CNR-07V(180K~391K)-TRXX		2000
CNR-07V(431K~821K)-TRXX		1500
CNR-10V(180K~621K)-TRXX		1000
CNR-10V(681K~112K)-TRXX		800
CNR-14V(180K~391K)-TRXX	56	800
CNR-14V(431K~621K)-TRXX		700
CNR-14V(681K~112K)-TRXX		600

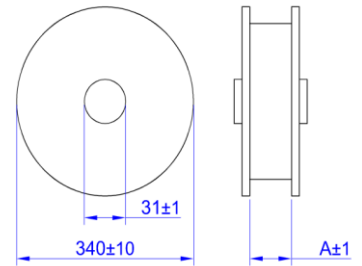

Box product packing

Series	Quantity (pcs/box)
CNR-05V(180K~621K)-BTXX	1000
CNR-05V(681K~751K)-BTXX	800
CNR-07V(180K~621K)-BTXX	1000
CNR-07V(681K~821K)-BTXX	800
CNR-10V(180K~621K)-BTXX	1000
CNR-10V(681K~112K)-BTXX	800
CNR-14V(180K~621K)-BTXX	500
CNR-14V(681K~112K)-BTXX	400

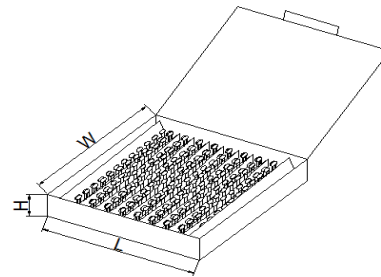

Series	L±5	W±5	H±5
CNR-05~07	340	245	45
CNR-10~14	340	245	50

Solder Recommendation

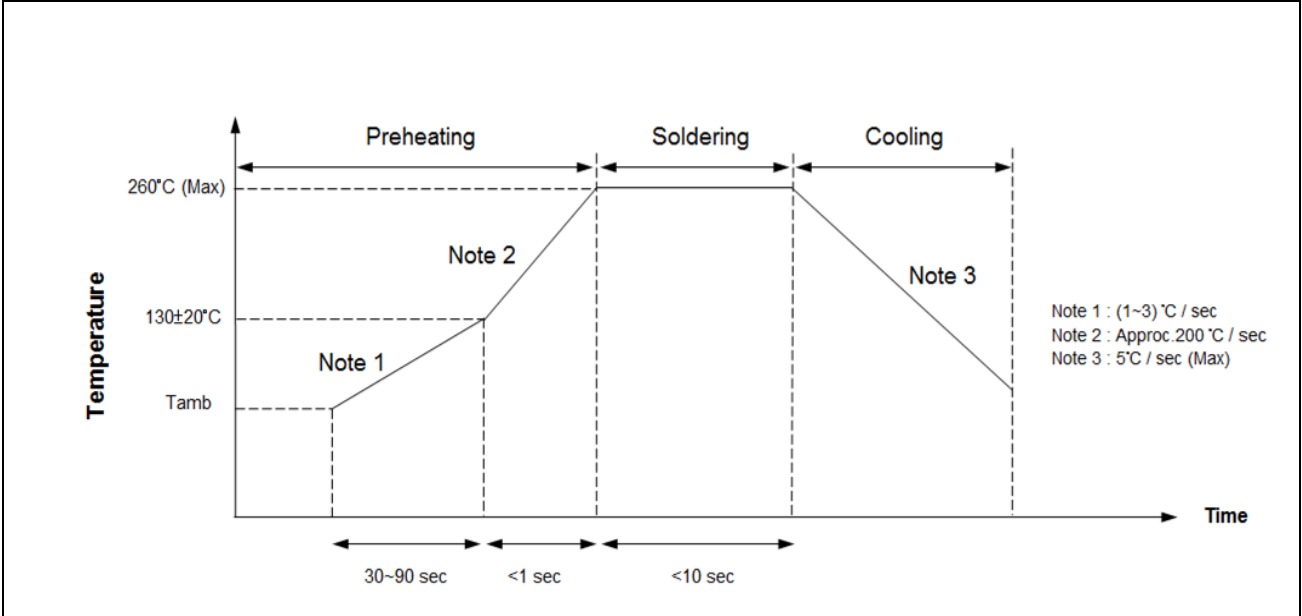

Recommendation Reworking Conditions with Soldering Iron

Item	Conditions
Temperature of soldering Iron-tip	360°C (Max)
Soldering Time	3 sec(Max)
Distance from Varistor	2mm(Min)

RoHS Compliant Declaration

We hereby declare that the components delivered to your company are compliant with RoHS Directive 2002/95/EC

Storage Conditions of Products

- (I) Storage Conditions:
- 1.Storage Temperature: -10°C~+40°C
 - 2.Relative Humidity: ≤75%RH
 - 3.Keep away from corrosive atmosphere and sunlight
 - 4.Solvent Resistance: MIL-STD-202, Method 215F
 - 5.Moisture Sensitivity: Level 1, J-STD-020

(II) Period of Storage: 1 year

Explanation of Part Numbers

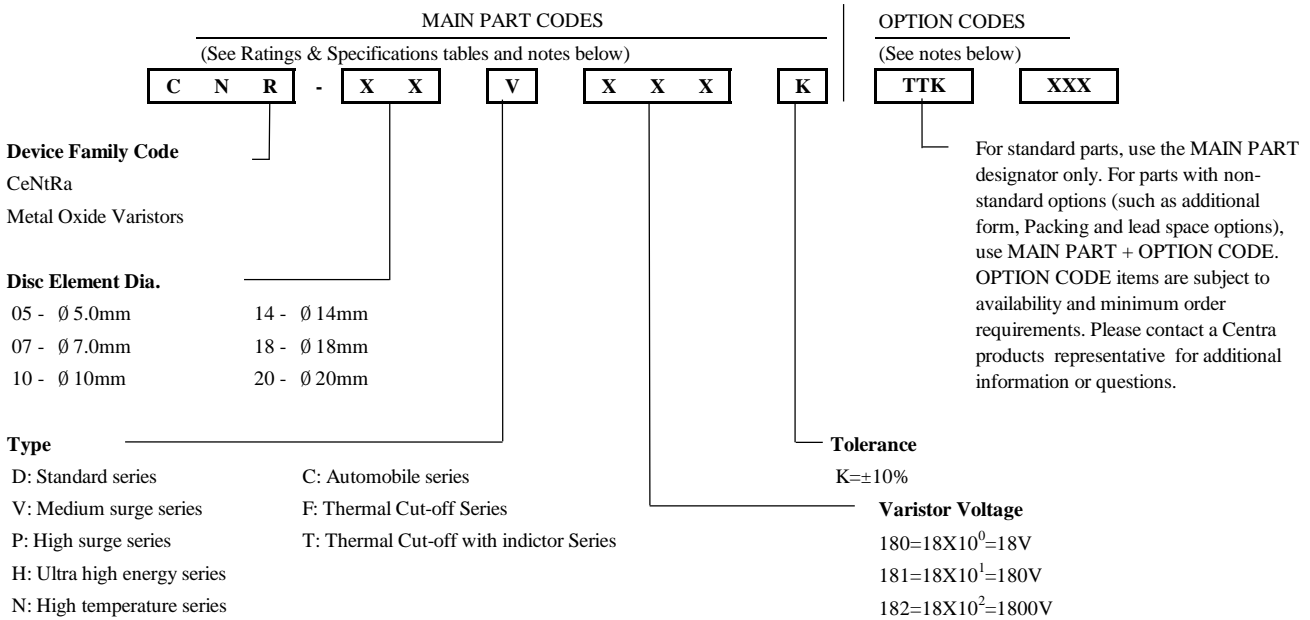

Ordering Notes:

MAIN PART CODES

Series + /Packaging/ Lead Style / Designators:

Ordering examples:

Straight Lead Bulk Pack (Standard)	Straight Lead (Short Cut) Bulk Pack	Straight Lead Tape & Reel Pack	Straight Lead Flat Box Pack
CNR-10V471K	CNR-10V471KTTSXXX	CNR-10V471KTRSX	CNR-10V471KBTSX

Outside Kink Lead Bulk Pack	Outside Kink Lead (Short Cut) Bulk Pack	Outside Kink Lead Tape & Reel Pack	Outside Kink Lead Flat Box Pack
CNR-10V471SOK	CNR-10V471KTTKXXX	CNR-10V471KTRKX	CNR-10V471KBTkX

Inside Kink Lead Bulk Pack	Inside Kink Lead (Short Cut) Bulk Pack	Inside Kink Lead Tape & Reel Pack	Inside Kink Lead Flat Box Pack
CNR-10V471KSIK	CNR-10V471KTTIXXX	CNR-10V471KTRIX	CNR-10V471KBTIX

In Line Kink Lead Bulk Pack	In Line Kink Lead (Short Cut) Bulk Pack	In Line Kink Lead Tape & Reel Pack	In Line Kink Lead Flat Box Pack
CNR-10V471KSHK	CNR-10V471KTTHXXX	CNR-10V471KTRHX	CNR-10V471KBTHX

Option Code

+ XXX

Short Cut Lead Length 10mm±1.0mm
CNR-10V471KTTS10

Tape & Reel Pack Feed Hole Pitch
CNR-10V471KTRSA
CNR-10V471KTRSB

A: P₀ → 12.7mm±0.2mm
B: P₀ → 15.0mm±0.2mm

CeNtRa V Series varistors are shipped standard in bulk pack with straight leads or Kink lead and lead spacing outlined in the Package Dimensions section of this data sheet. Contact your CeNtRa sales representative to discuss non-standard options.