





Device Ratings and Characteristics														
Part No.	Device Marking	Maximum Allowable Voltage		Varistor Voltage (@1mA)			Clamping Voltage @ Test Current (@8/20µs)		Maximum Energy (@10/1000µs)	Maximum Peak Current (@8/20µs)	Rated Power (W)	Typical Capacitance (@1KHz) (pF)	UL 1449 4th, In @8/20us (KA)	Related Standards Symbol
		ACrms(V)	DC(V)	Vn(Vdc)	Min.	Max.	Vc(V)	Ip(A)	(J)	(A)				
CNR-10N180K	10N180K	11	14	18	16	20	36	5	4	1500	0.08	8000	1	⊙
CNR-10N220K	10N220K	14	18	22	20	24	43	5	5	1500	0.08	7000		⊙
CNR-10N270K	10N270K	17	22	27	24	30	53	5	6	1500	0.08	5500		⊙
CNR-10N330K	10N330K	20	26	33	30	36	65	5	7.5	1500	0.08	4100		⊙
CNR-10N390K	10N390K	25	31	39	35	43	77	5	8.6	1500	0.08	3900		⊙
CNR-10N470K	10N470K	30	38	47	42	52	93	5	10	1500	0.08	3300		⊙
CNR-10N560K	10N560K	35	45	56	50	62	110	5	11	1500	0.08	2800		⊙
CNR-10N680K	10N680K	40	56	68	61	75	135	5	14	1500	0.08	2300		⊙
CNR-10N201K	10N201K	130	170	200	180	220	340	50	52	4500	0.5	420	2	□
CNR-10N221K	10N221K	140	180	220	198	242	360	50	58	4500	0.5	390		□
CNR-10N241K	10N241K	150	200	240	216	264	395	50	64	4500	0.5	360		□
CNR-10N271K	10N271K	175	225	270	243	297	455	50	67	4500	0.5	330		□
CNR-10N301K	10N301K	195	250	300	270	330	500	50	70	4500	0.5	300		□
CNR-10N331K	10N331K	215	275	330	297	363	550	50	78	4500	0.5	270		□
CNR-10N361K	10N361K	230	300	360	324	396	595	50	84	4500	0.5	250		□
CNR-10N391K	10N391K	250	320	390	351	429	650	50	91	4500	0.5	230		□
CNR-10N431K	10N431K	275	350	430	387	473	710	50	99	4500	0.5	220		□
CNR-10N471K	10N471K	300	385	470	423	517	775	50	107	4500	0.5	200		□
CNR-10N511K	10N511K	320	420	510	459	561	845	50	117	4500	0.5	190		□
CNR-10N561K	10N561K	350	460	560	504	616	915	50	125	4500	0.5	180		□
CNR-10N621K	10N621K	395	510	620	558	682	1020	50	128	4500	0.5	160		□
CNR-10N681K	10N681K	420	560	680	612	748	1120	50	134	4500	0.5	140		□
CNR-10N751K	10N751K	465	615	750	675	825	1235	50	146	4500	0.5	130		□

### Related Standards

Symbols	□	⊙
Approval	    	

Note : VDE & CQC Certification are under appovaling

**Reliability**

Characteristics	Standard	Test Conditions	Specifications
Robustness of terminations	IEC 60068-2-21 Test Ua1	F = 10 N (d ≤ 0.8 mm) ,F = 20 N ( d = 1 mm)	$\Delta V/V \leq \pm 10\%$ No visible damage
Solderability	IEC 60068-2-20 Test Ta (Method 1)	T = 235±5 °C, d = 2±0.5s	Approximately ≥ 95%
Resistance to soldering heat	IEC 60068-2-20 Test Tb (Method 1A)	T = 260±5 °C, d = 10±1s	$\Delta V/V \leq \pm 10\%$ No visible damage
Shock	IEC 60068-2-27 Test Ea	Pulse shape: half-sine. a = 490 m/s <sup>2</sup> , d = 11ms. N = 6 x 3 shocks	$\Delta V/V \leq \pm 10\%$ No visible damage
Vibration	IEC 60068-2-6 Test Fc Method B4	Frequency range: 10 Hz to 55 Hz ,a = 0.75 mm or 98 m/s <sup>2</sup> (whichever is the less), d = 3x2 h	$\Delta V/V \leq \pm 10\%$ No visible damage
Needle flame test	IEC 60695-11-5	Severity: Vertical 10 s	Duration of burning: 5 s max.
Voltage under pulse condition	IEC 61051-2	At class current	As specified in specification
Voltage proof	IEC 61051-2	Metal balls method (4.8.1.2) 2500 V, 60 s	As specified in specification
Pulse current - 8/20 μs	IEC 61051-2	8/20 μs, 10 times, I peak=0.25*Imax	$\Delta V/V \leq \pm 10\%$ No visible damage
Pulse current - 10/1000 μs	IEC 61051-2	10/1000 μs, 10 times, Ipeak = 0.0075* Imax	$\Delta V/V \leq \pm 10\%$ No visible damage
Combination pulse	IEC 60950-1:2013 Annex Q	Additional test: 10 pulses (combination pulse 6KV/3KA), in one direction, 1 per min	$\Delta V/V \leq \pm 10\%$ No visible damage U ≤ 1.1 Uinitial Voltage proof:No breakdown or flashover
Rapid change of temperature	IEC 60068-2-14 Test Na	N = 5 cycles, d = 30 min , θA = -40±3°C, θB = 85±2°C	$\Delta V/V \leq \pm 10\%$ No visible damage
Climatic sequence	IEC 60068-2-2 Test Ba IEC 60068-2-30 Test Db IEC 60068-2-1 Test Aa IEC 60068-2-30 Test Db	Dry heat, Test Ba:16±2h, T = 85±2°C Damp heat, Test Db first cycle :24h, T = 55±2°C Cold, Test Aa :2h, T = -40±3°C Damp heat Test Ba remaining cycles:5 cycle	$\Delta V/V \leq \pm 10\%$ No visible damage RISO ≥ 100MΩ Voltage proof:No breakdown or flashover
Endurance at upper category temperature	IEC 61051-1 (4.21)	T:max temperature as specified , Duration: 1000 h, Voltage: max. a.c. voltage	$\Delta V/V \leq \pm 10\%$ No visible damage R ≥ 1000MΩ U ≤ 1,1 Uinitial

**Reliability**

Characteristics	Standard	Test Conditions	Specifications
Damp heat (Steady state)	IEC 60068-2-78 Test Ca	T = 40±2°C, RH = 93(+2/-3)%, 56d , 4 specimens:No voltage applied , Other 4 specimens:Applied voltage: 10% of the max. d.c. voltage	$\Delta V/V \leq \pm 10\%$ RISO $\geq 100M\Omega$
Maximum Peak Current	Specification Standard	$I_{max}$ , 8/20 $\mu$ s, 1 time $\frac{V_{1mA \text{ at } 85^\circ C} - V_{1mA \text{ at } 25^\circ C}}{V_{1mA \text{ at } 25^\circ C}} \times \frac{1}{60} \times 100(\%/C)$	$-0.05 \leq TC \leq 0.05(\%/C)$
Nominal Discharge Current Test	UL1449 4th	Nominal Discharge Current (In), 8/20 $\mu$ s, 15 times	$\Delta V/V \leq \pm 10\%$ No visible damage
Varistor Voltage Temp. Coefficient	Specification Standard	V1mA at -40°C, 85°C, 25°C	$\Delta V/V \leq \pm 10\%$ No visible damage
High Temperature Storage	IEC60068-2-2	1000h, T = 85±2°C	$\Delta V/V \leq \pm 10\%$ No visible damage
Max. Energy	Specification Standard	10/1000 $\mu$ s, 1 times, Max. Energy	$\Delta V/V \leq \pm 10\%$ No visible damage
Operating duty cycle test *	UL 1449	6 kV/3 kA combination wave surges, phase angle of 90 (+0, -15) degrees, npositive polarity 8 times, negative polarity 7 times, interval of 60s.	$\Delta V/V \leq \pm 10\%$ No visible damage
Surge Immunity Test*	IEC 61000-4-5	4kV/2kA combination wave surges, phase angle of 90 (+0, -15) degrees, npositive polarity 20times, negative polarity 20times, interval of 60s.	$\Delta V/V \leq \pm 10\%$ No visible damage

\* (According to customer requirements to meet the test items)

**Impulse Life Time Rating Curves**

**CNR-10N180K to CNR-10N680K**

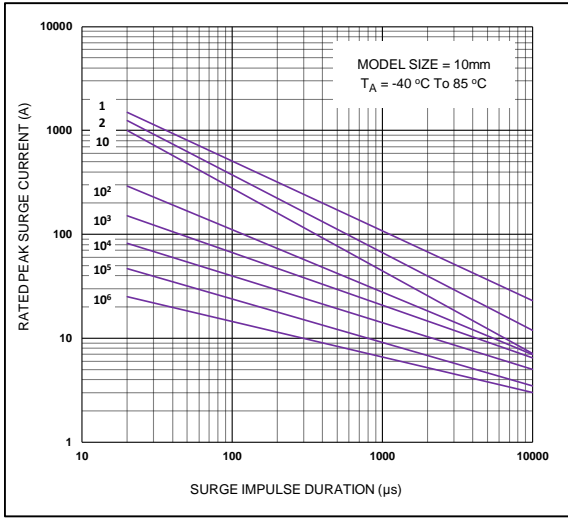

**CNR-10N201K to CNR-10N112K**

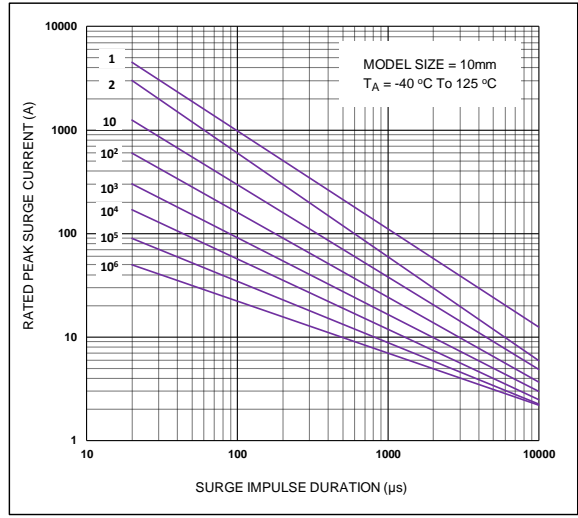

**CNR-10N180K to CNR-10N680K V-I Curves**

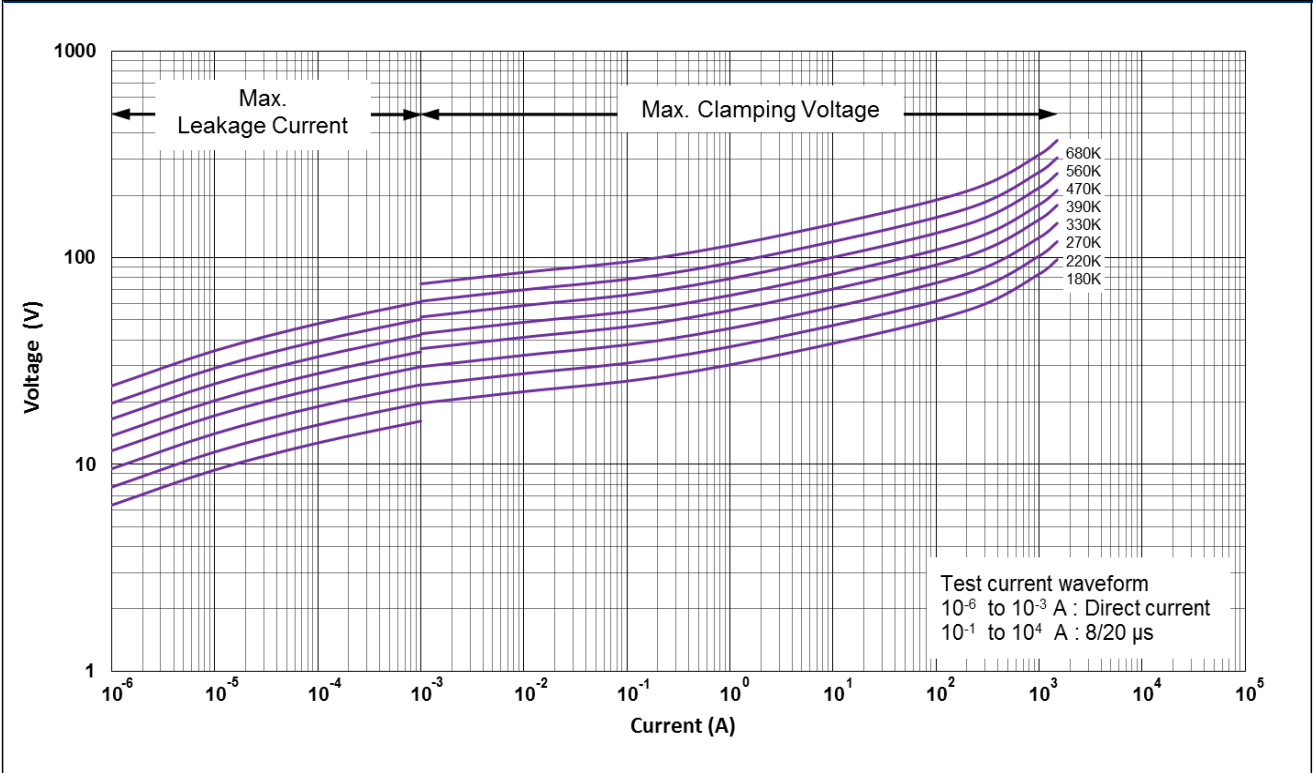

**CNR-10N201K to CNR-10N751K V-I Curves**

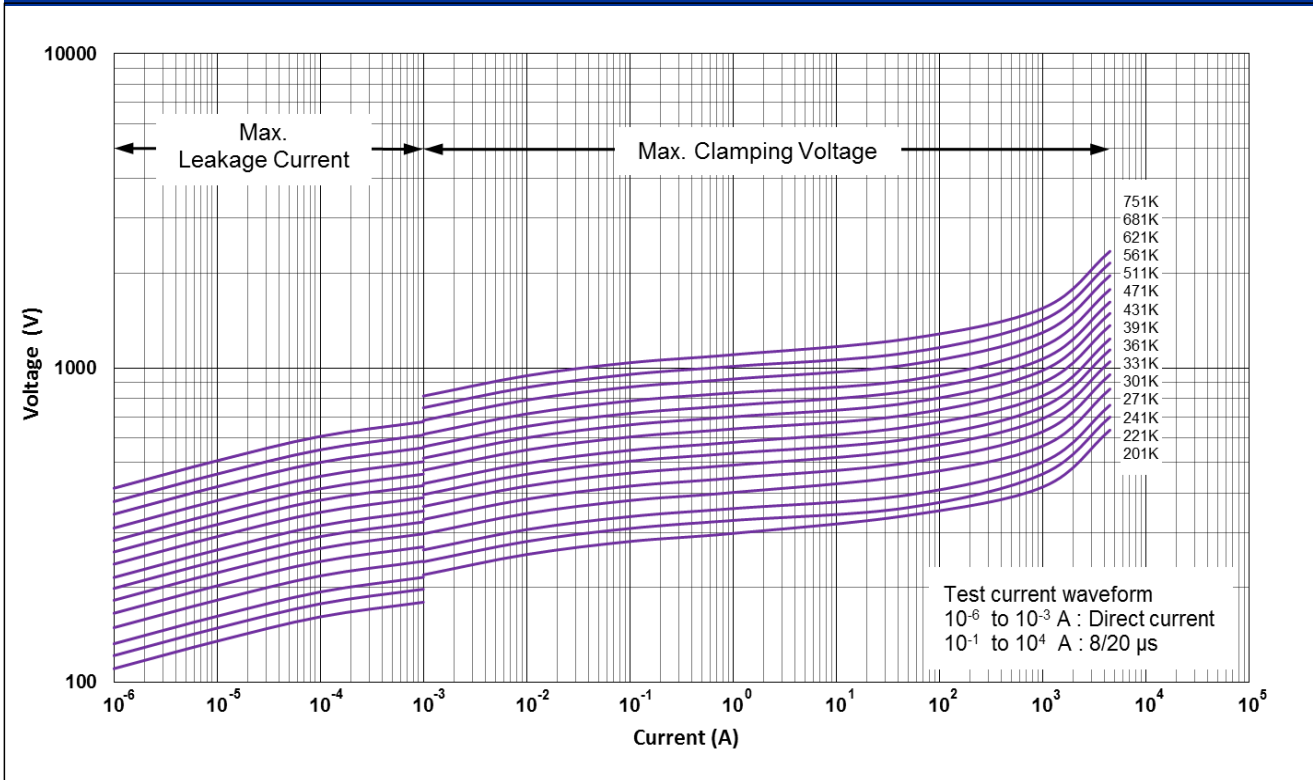

Power Derating Curve

Should transients occur in rapid succession, the average power dissipation is the energy (watt-seconds) per pulse times the number of pulses per second. The power so developed must be with the specifications shown on the Device Ratings and Specifications Table for the specific device. The operating values of a MOV need to be derated at high temperatures as shown above. Because varistors only dissipate a relatively small amount of average power they are not suitable for repetitive applications that involve substantial amounts of average power dissipation.

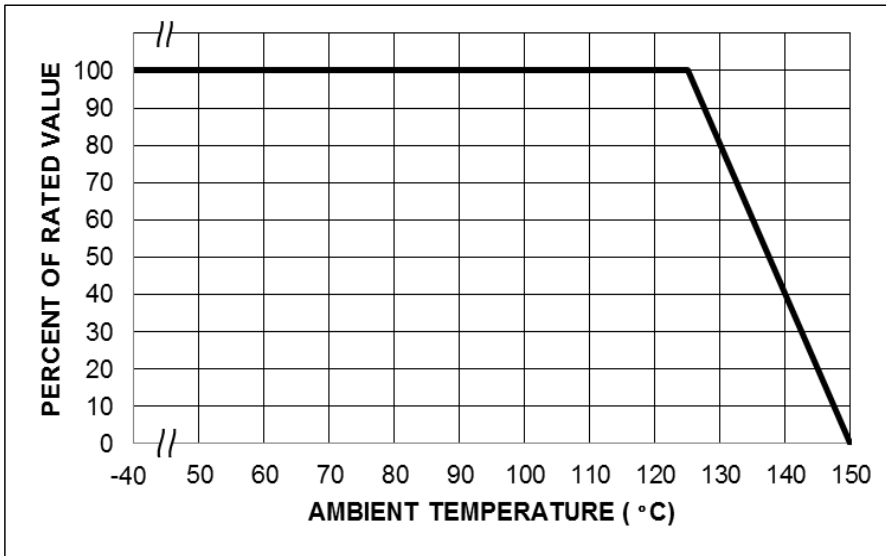

Surge Current Standard Waveform

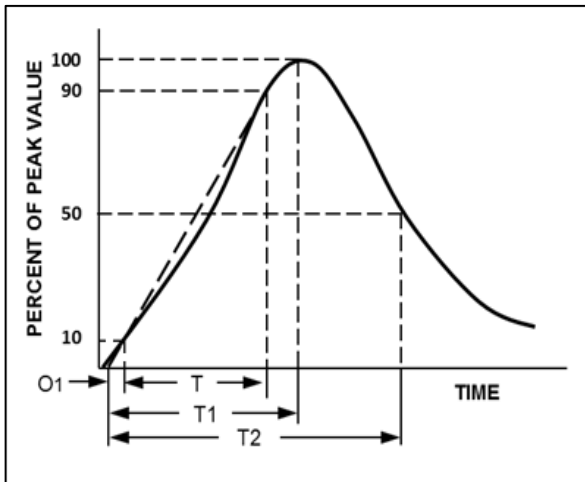

O1 = Virtual Origin of Wave  
 T = Time from 10% to 90% of Peak  
 $T1 = \text{Rise Time} = 1.25 \times T$   
 $T2 = \text{Decay Time}$   
 Example - For an 8/20  $\mu\text{s}$  Current Waveform:  
 $8\mu\text{s} = T1 = \text{Rise Time}$   
 $20\mu\text{s} = T2 = \text{Decay Time}$

Product Dimensions

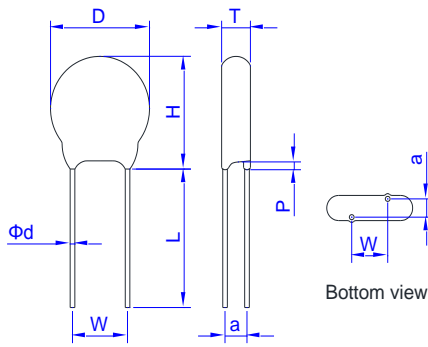

Fig 1. Straight Lead

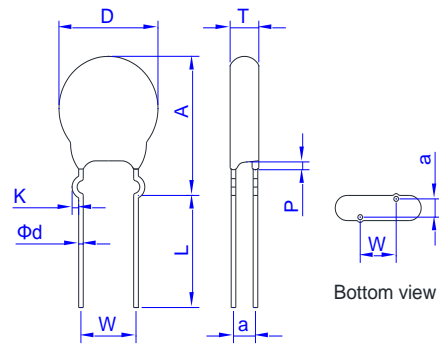

Fig 2. Outside Kink Lead

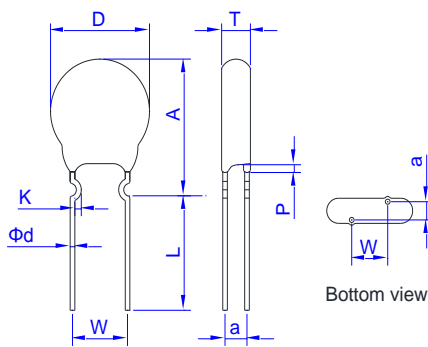

Fig 3. Inside Kink Lead

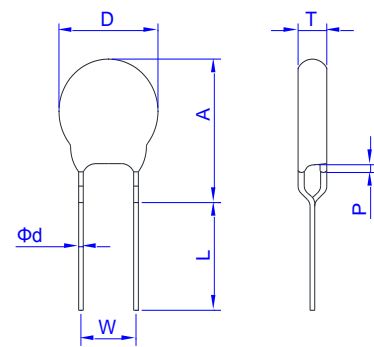

Fig 4. In Line Kink Lead

Dimension Table

Unit:mm

Model		05N		07N		10N		14N		18N		20N	
		Min.	Max.	Min.	Max.	Min.	Max.	Min.	Max.	Min.	Max.	Min.	Max.
Symbol													
D		5.5	7.5	7.5	9.0	10.5	14.0	13.5	17.5	18.5	23.0	19.5	25.0
H		-	10.0	-	12.0	-	17.0	-	20.5	-	26.0	-	28.0
W		4.0	6.0	4.0	6.0	6.5	8.5	6.5	8.5	6.5	8.5	9.0	11.0
Φd		0.55	0.65	0.55	0.65	0.75	0.85	0.75	0.85	0.75	0.85	0.95	1.05
P(max.)		3.0											
L(min)		25.0											
K(Kink Lead)		0.8	1.6	0.8	1.6	1.0	1.8	1.0	1.8	1.0	1.8	1.0	1.8
A(max.)	180K-271K	-	13.0	-	15.0	-	19.5	-	22.5	-	26.5	-	30.0
	>271K	-	13.0	-	15.0	-	20.5	-	23.5	-	27.0	-	31.0
T		See Tmax table											

\* Short Cut Lead type TTXX the lead length (L) can 3.0~15mm (except 20N dia <10mm), see Ordering Note.

\* \* a value see T max. table

T max. Table								Unit:mm							
Model	05N	07N	10N	14N	18N	20N	a(±1.0)	Model	05N	07N	10N	14N	18N	20N	a(±1.0)
180K	4.7	4.7	5.3	5.3	5.3	5.3	1.5	271K	6.1	6.6	6.6	6.6	6.6	6.6	2.3
220K	5.1	5.1	5.6	5.6	5.6	5.6	1.7	301K	6.2	6.8	6.8	6.8	6.8	6.8	2.5
270K	5.3	5.3	5.9	5.9	5.9	5.9	1.8	331K	6.4	7	7	7	7	7	2.7
330K	4.7	4.7	5.3	5.3	5.3	5.3	1.9	361K	6.5	7.3	7.3	7.3	7.3	7.3	2.8
390K	4.9	4.9	5.5	5.5	5.5	5.5	1.9	391K	6.8	7.5	7.5	7.5	7.5	7.5	3
470K	5.2	5.2	5.8	5.8	5.8	5.8	2.1	431K	7.1	7.8	7.8	7.8	7.8	7.8	3.2
560K	5.6	5.6	6.1	6.1	6.1	6.1	2.3	471K	7.4	8.1	8.1	8.1	8.1	8.1	3.4
680K	6	6	6.5	6.5	6.5	6.5	2.6	511K	7.8	8.2	8.2	8.2	8.2	8.2	3.7
201K	5.1	6.2	6.2	6.2	6.2	6.2	2	561K	8.2	8.5	8.5	8.5	8.5	8.5	3.9
221K	5.3	6.3	6.3	6.3	6.3	6.3	2.1	621K	8.4	8.8	8.8	8.8	8.8	8.8	4.3
241K	5.4	6.5	6.5	6.5	6.5	6.5	2.2	681K	8.7	8.9	8.9	8.9	8.9	8.9	4.7
								751K	9	9.2	9.2	9.2	9.2	9.2	5.1



**Tape and Reel Specifications**

- Radial devices on tape are supplied with kinked leads, straight leads or in-line leads

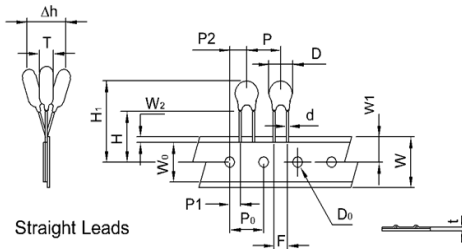
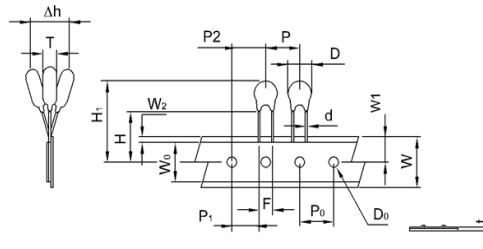
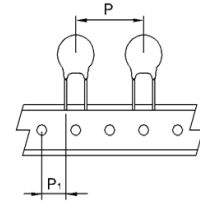
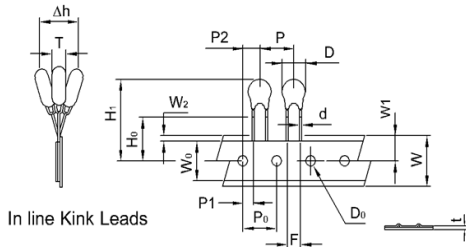
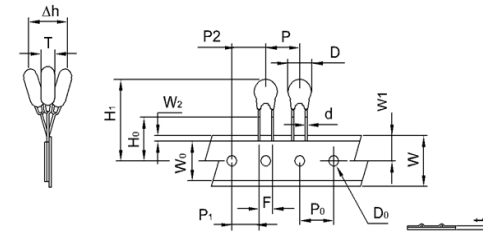
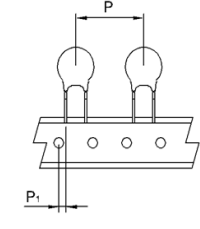
**Figure: A**

**Figure: B**

**Figure: C**

**Figure: D**

**Figure: E**

**Figure: F**

Symbol	Description	Model Size					
		05N	07N	10N	10N	14N	14N
P	Pitch of Component	12.7±1.0	12.7±1.0	12.7±1.0	15.0±1.0	25.4±1.0	30.0±1.0
P <sub>0</sub>	Feed Hole Pitch	12.7±0.2	12.7±0.2	12.7±0.2	15.0±0.2	12.7±0.2	15.0±0.2
P <sub>1</sub>	Feed Hole Center to Pitch	3.85±0.7	3.85±0.7	8.95±0.7	3.75±0.7	8.95±0.7	3.75±0.7
P <sub>2</sub>	Hole Center to Component Center	6.35±0.7	6.35±0.7	12.7±0.7	7.5±0.7	12.7±0.7	7.5±0.7
F	Lead to Lead Distance	5.0±0.8	5.0±0.8	7.5±0.8	7.5±0.8	7.5±0.8	7.5±0.8
Δh	Component Alignment	2.0max	2.0max	2.0max	2.0max	2.0max	2.0max
W	Tape Width	18.0+1.0	18.0+1.0	18.0+1.0	18.0+1.0	18.0+1.0	18.0+1.0
		18.0-0.5	18.0-0.5	18.0-0.5	18.0-0.5	18.0-0.5	18.0-0.5
W <sub>0</sub>	Hold Down Tape Width	5.0 Min.	5.0 Min.	5.0 Min.	5.0 Min.	5.0 Min.	5.0 Min.
W <sub>1</sub>	Hole Position	9.0+0.75	9.0+0.75	9.0+0.75	9.0+0.75	9.0+0.75	9.0+0.75
		9.0-0.5	9.0-0.5	9.0-0.5	9.0-0.5	9.0-0.5	9.0-0.5
W <sub>2</sub>	Hold Down Tape Position	3.0 Max	3.0 Max	3.0 Max	3.0 Max	3.0 Max	3.0 Max
H	Height from Tape Center to Component Base	18.0+2.0	18.0+2.0	18.0+2.0	18.0+2.0	18.0+2.0	18.0+2.0
		18.0-0.0	18.0-0.0	18.0-0.0	18.0-0.0	18.0-0.0	18.0-0.0
H <sub>0</sub>	Seating Plane Height	16.0±0.5	16.0±0.5	16.0±0.5	16.0±0.5	16.0±0.5	16.0±0.5
H <sub>1</sub>	Component Height	32.0 Max.	32.0 Max.	36.0 Max.	36.0 Max.	40.0 Max.	40.0 Max.
D <sub>0</sub>	Feed Hole Diameter	4.0±0.2	4.0±0.2	4.0±0.2	4.0±0.2	4.0±0.2	4.0±0.2
t	Total Tape Thickness	0.7±0.2	0.7±0.2	0.7±0.2	0.7±0.2	0.7±0.2	0.7±0.2
L	Length Clipped Lead	11.0 Max	11.0 Max	11.0 Max	11.0 Max	11.0 Max	11.0 Max
Figure		A, D	A, D	B, E	A, D	C	F

**Tape and Reel Specifications**

- Radial devices on tape are supplied with kinked leads, straight leads or in-line leads

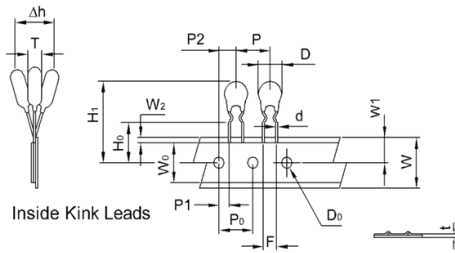

Figure: A

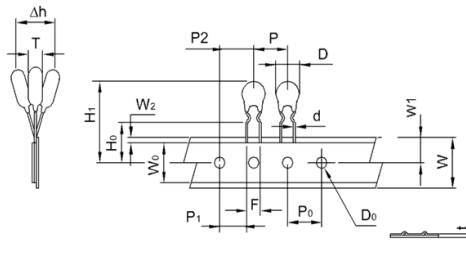

Figure: B

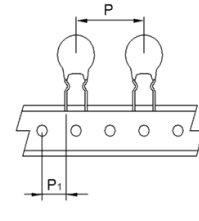

Figure: C

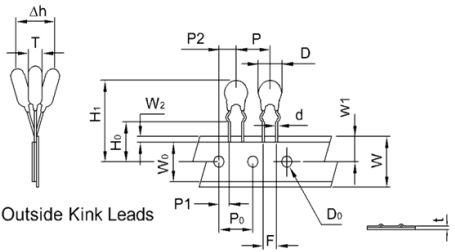

Figure: D

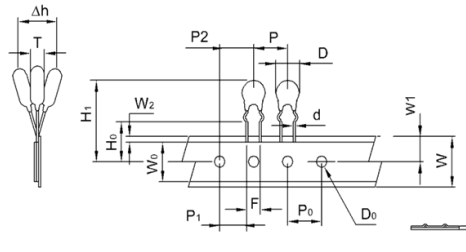

Figure: E

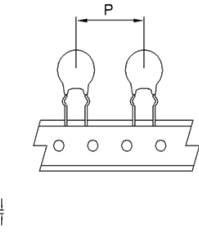

Figure: F

Symbol	Description	Model Size					
		05N	07N	10N	10N	14N	14N
P	Pitch of Component	12.7±1.0	12.7±1.0	12.7±1.0	15.0±1.0	25.4±1.0	30.0±1.0
P <sub>0</sub>	Feed Hole Pitch	12.7±0.2	12.7±0.2	12.7±0.2	15.0±0.2	12.7±0.2	15.0±0.2
P <sub>1</sub>	Feed Hole Center to Pitch	3.85±0.7	3.85±0.7	8.95±0.7	3.75±0.7	8.95±0.7	3.75±0.7
P <sub>2</sub>	Hole Center to Component Center	6.35±0.7	6.35±0.7	12.7±0.7	7.5±0.7	12.7±0.7	7.5±0.7
F	Lead to Lead Distance	5.0±0.8	5.0±0.8	7.5±0.8	7.5±0.8	7.5±0.8	7.5±0.8
△h	Component Alignment	2.0max	2.0max	2.0max	2.0max	2.0max	2.0max
W	Tape Width	18.0+1.0	18.0+1.0	18.0+1.0	18.0+1.0	18.0+1.0	18.0+1.0
		18.0-0.5	18.0-0.5	18.0-0.5	18.0-0.5	18.0-0.5	18.0-0.5
W <sub>0</sub>	Hold Down Tape Width	5.0 Min.	5.0 Min.	5.0 Min.	5.0 Min.	5.0 Min.	5.0 Min.
W <sub>1</sub>	Hole Position	9.0+0.75	9.0+0.75	9.0+0.75	9.0+0.75	9.0+0.75	9.0+0.75
		9.0-0.5	9.0-0.5	9.0-0.5	9.0-0.5	9.0-0.5	9.0-0.5
W <sub>2</sub>	Hold Down Tape Position	3.0 Max	3.0 Max	3.0 Max	3.0 Max	3.0 Max	3.0 Max
H	Height from Tape Center to Component Base	18.0+2.0	18.0+2.0	18.0+2.0	18.0+2.0	18.0+2.0	18.0+2.0
		18.0-0.0	18.0-0.0	18.0-0.0	18.0-0.0	18.0-0.0	18.0-0.0
H <sub>0</sub>	Seating Plane Height	16.0±0.5	16.0±0.5	16.0±0.5	16.0±0.5	16.0±0.5	16.0±0.5
H <sub>1</sub>	Component Height	29.0 Max.	32.0 Max.	36.0 Max.	36.0 Max.	40.0 Max.	40.0 Max.
D <sub>0</sub>	Feed Hole Diameter	4.0±0.2	4.0±0.2	4.0±0.2	4.0±0.2	4.0±0.2	4.0±0.2
t	Total Tape Thickness	0.7±0.2	0.7±0.2	0.7±0.2	0.7±0.2	0.7±0.2	0.7±0.2
L	Length Clipped Lead	11.0 Max	11.0 Max	11.0 Max	11.0 Max	11.0 Max	11.0 Max
Figure		A, D	A, D	B, E	A, D	C	F

**Packing information**

Bulk packing

Series	Straight Lead Type Quantity(pcs/bag)	Cut Lead Type Quantity(pcs/bag)	Kink Type Quantity(pcs/bag)
CNR-05N	1000	1000	1000
CNR-07N	1000	1000	1000
CNR-10N	500	500	500
CNR-14N	500	500	500
CNR-18N	250	250	250
CNR-20N	250	250	250

Tape & Reel product packing

Series	A (mm)	Quantity (pcs/reel)
CNR-05N(201K~621K)-TRXX	43	2000
CNR-05N(681K~781K)-TRXX		1500
CNR-07N(201K~391K)-TRXX		2000
CNR-07N(431K~821K)-TRXX		1500
CNR-07N(201K~391K)-TRXX		2000
CNR-07N(431K~821K)-TRXX		1500
CNR-10N(201K~621K)-TRXX	56	1000
CNR-10N(681K~112K)-TRXX		800
CNR-14N(201K~391K)-TRXX		800
CNR-14N(431K~621K)-TRXX		700
CNR-14N(681K~112K)-TRXX		600

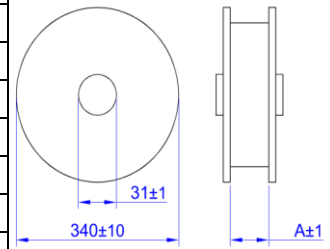

Flat Box product

Series	Quantity (pcs/box)
CNR-05N(201K~621K)-BTXX	1000
CNR-05N(681K~781K)-BTXX	800
CNR-07N(201K~621K)-BTXX	1000
CNR-07N(681K~781K)-BTXX	800
CNR-10N(201K~621K)-BTXX	1000
CNR-10N(681K~112K)-BTXX	800
CNR-14N(201K~621K)-BTXX	500
CNR-14N(681K~112K)-BTXX	400

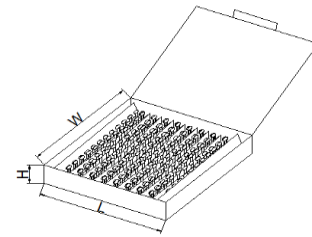

Series	L±5	W±5	N±5
CNR-05N~07N	340	245	45
CNR-10N~14N	340	245	50

**Solder Recommendation**

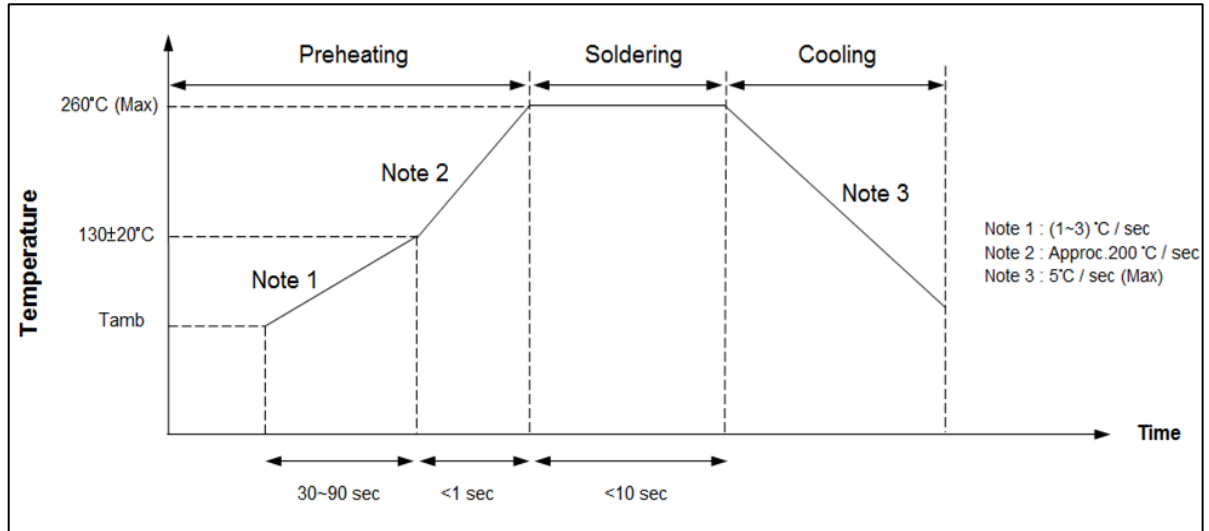

**Recommendation Reworking Conditions with Soldering Iron**

Item	Conditions
Temperature of soldering Iron-tip	360°C (Max)
Soldering Time	3 sec (Max)
Distance from Varistor	2mm (Min)

**RoHS Compliant Declaration**

We hereby declare that the components delivered to your company are compliant with RoHS Directive 2002/95/EC

**Storage Conditions of Products**

(I) Storage Conditions:

- 1.Storage Temperature: -10°C ~+40°C
- 2.Relative Humidity: ≤ 75% RH
- 3.Keep away from corrosive atmosphere and sunlight
- 4.Solvent Resistance: MIL-STD-202, Method 215F
- 5.Moisture Sensitivity: Level 1, J-STD-020

(II) Period of Storage: 1 year

## Explanation of Part Numbers

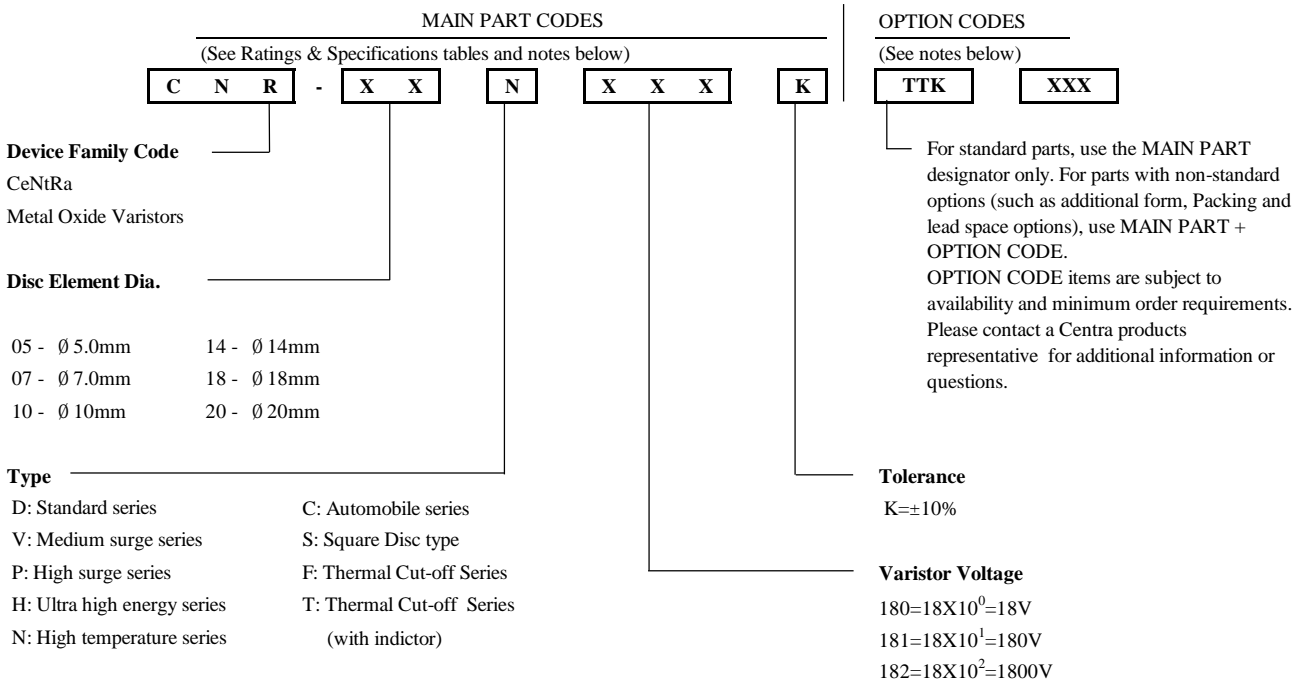

### Ordering Notes:

#### MAIN PART CODES

Series + /Packaging/ Lead Style / Designators:

Ordering examples:

Straight Lead Bulk Pack (Standard)	Straight Lead (Short Cut) Bulk Pack	Straight Lead Tape & Reel Pack	Straight Lead Flat Box Pack
CNR-10N471K	CNR-10N471KTTSXXX	CNR-10N471KTRSX	CNR-10N471KBTSX

Outside Kink Lead Bulk Pack	Outside Kink Lead (Short Cut) Bulk Pack	Outside Kink Lead Tape & Reel Pack	Outside Kink Lead Flat Box Pack
CNR-10N471SOK	CNR-10N471KTTKXXX	CNR-10N471KTRKX	CNR-10N471KBTKX

Inside Kink Lead Bulk Pack	Inside Kink Lead (Short Cut) Bulk Pack	Inside Kink Lead Tape & Reel Pack	Inside Kink Lead Flat Box Pack
CNR-10N471KSIK	CNR-10N471KTTIXXX	CNR-10N471KTRIX	CNR-10N471KBTIX

In Line Kink Lead Bulk Pack	In Line Kink Lead (Short Cut) Bulk Pack	In Line Kink Lead Tape & Reel Pack	In Line Kink Lead Flat Box Pack
CNR-10N471KSHK	CNR-10N471KTTHXXX	CNR-10N471KTRHX	CNR-10N471KBTHX

Option Code

+ XXX

Short Cut Lead Length 10mm±1.0mm
CNR-10N471KTTS10

Tape & Reel Pack Feed Hole Pitch
CNR-10N471KTRSA
CNR-10N471KTRSB

A: P<sub>0</sub> → 12.7mm±0.2mm  
B: P<sub>0</sub> → 15.0mm±0.2mm

CeNtRa N Series varistors are shipped standard in bulk pack with straight leads or Kink lead and lead spacing outlined in the Package Dimensions section of this data sheet. Contact your CeNtRa sales representative to discuss non-standard options.