

Description

The USM08C is a bi-directional TVS diode array, utilizing leading monolithic silicon technology to provide fast response time and low ESD clamping voltage, making this device an ideal solution for protecting sensitive semiconductor components from damage. The USM08C complies with the IEC 61000-4-2 (ESD) standard with $\pm 30\text{kV}$ air and $\pm 30\text{kV}$ contact discharge. It is assembled into a lead-free SOT-23 package. It is designed to protect components which are connected to data and transmission lines from voltage surges.

Mechanical Characteristics

- ◆ Package: SOT-23
- ◆ Lead Finish: Matte Tin
- ◆ Case Material: "Green" Molding Compound.
- ◆ UL Flammability Classification Rating 94V-0
- ◆ Moisture Sensitivity: Level 3 per J-STD-020
- ◆ Terminal Connections: See Diagram Below
- ◆ Marking Information: See Below

Dimensions and Pin Configuration

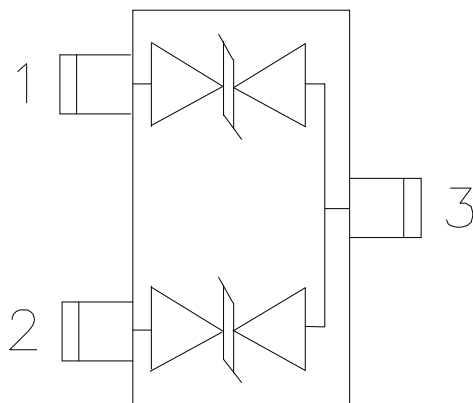

Circuit and Pin Schematic

Features

- ◆ 300W peak pulse power(8/20 μs)
- ◆ Protects two bi-directional lines
- ◆ Ultra low leakage: nA level
- ◆ Operating voltage: 8V
- ◆ Low clamping voltage
- ◆ Complies with following standards:
 - IEC 61000-4-2 (ESD) immunity test
 - Air discharge: $\pm 30\text{kV}$
 - Contact discharge: $\pm 30\text{kV}$
 - IEC61000-4-4 (EFT) 40A (5/50ns)
- ◆ RoHS Compliant

Applications

- ◆ Cellular Handsets and Accessories
- ◆ Notebooks and Handhelds
- ◆ Portable Instrumentation
- ◆ Set Top Box
- ◆ Industrial Controls
- ◆ Server and Desktop PC

Marking Information

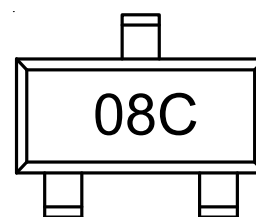

xx represents the voltage

Ordering Information

Part Number	Marking	Packaging	Reel Size
USM08C	08C	3000/Tape & Reel	7 inch

Absolute Maximum Ratings ($T_A=25^{\circ}\text{C}$ unless otherwise specified)

Parameter	Symbol	Value	Unit
Peak Pulse Power(8/20 μs)	Ppk	300	W
ESD per IEC 61000-4-2 (Air)	VESD	± 30	kV
ESD per IEC 61000-4-2 (Contact)		± 30	
Operating Temperature Range	TJ	-55 to +125	$^{\circ}\text{C}$
Storage Temperature Range	Tstg	-55 to +150	$^{\circ}\text{C}$

Electrical Characteristics ($T_A=25^{\circ}\text{C}$ unless otherwise specified)

USM08C (Marking Code: 08C)						
Parameter	Symbol	Min	Typ	Max	Unit	Test Condition
Reverse Working Voltage	VRWM			8	V	
Breakdown Voltage	VBR	8.5			V	$I_T = 1\text{mA}$
Reverse Leakage Current	IR		0.01	0.5	μA	$V_{RWM} = 8\text{V}$
Clamping Voltage	VC		10		V	$I_{PP} = 1\text{A}$ (8 x 20 μs pulse)
Clamping Voltage	VC		15		V	$I_{PP} = 20\text{A}$ (8 x 20 μs pulse)
Peak Pulse Current	I _{PP}			20	A	$t_P=8/20\mu\text{s}$
Junction Capacitance	CJ			100	pF	$V_R=0$, $f=1\text{MHz}$, Pin 1 to Pin 3 or Pin 2 to Pin 3

Typical Performance Characteristics (TA=25°C unless otherwise Specified)

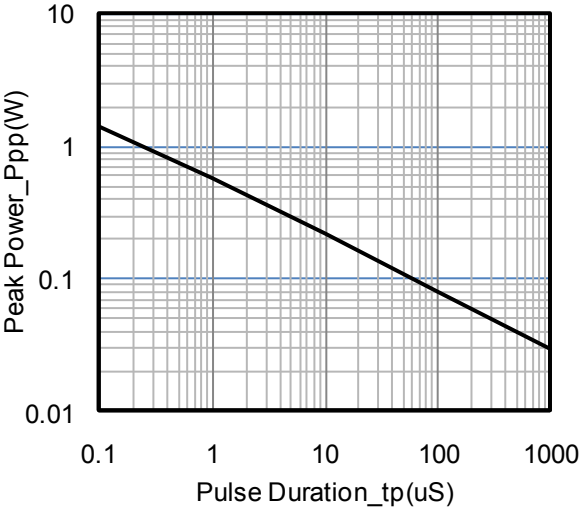

Peak Pulse Power vs. Pulse Time

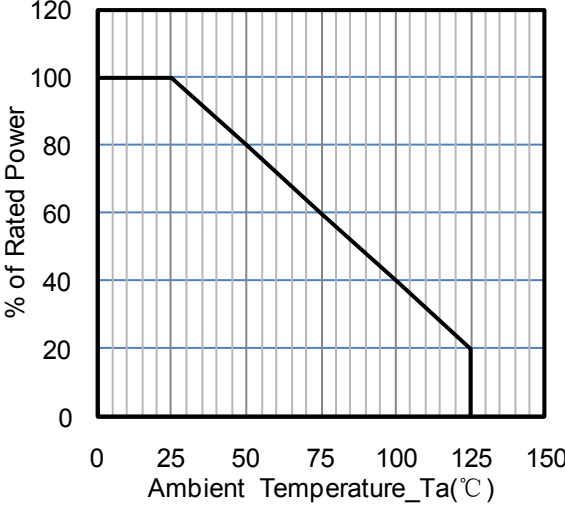

Power Derating Curve

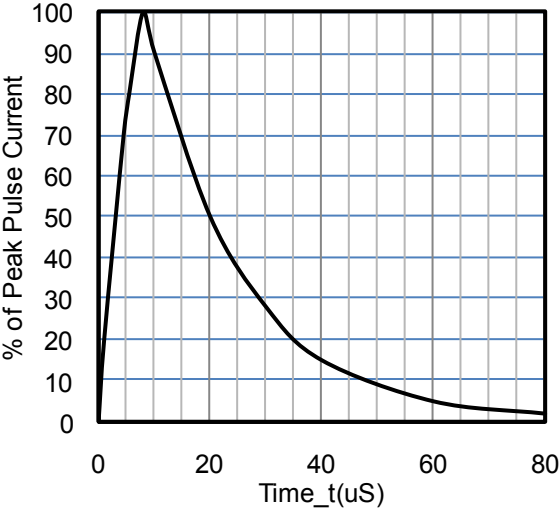

8X 20µs Pulse Waveform

SOT-23 Package Outline Drawing

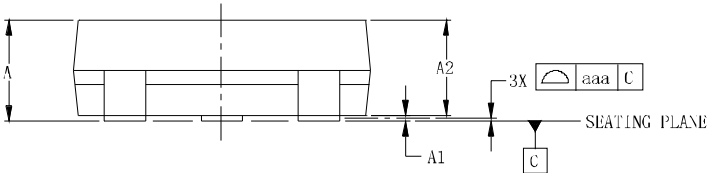
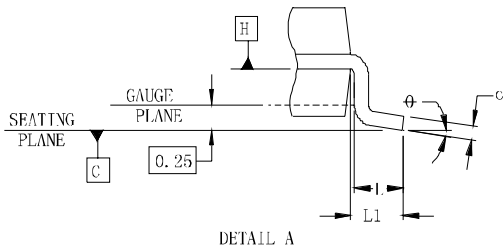
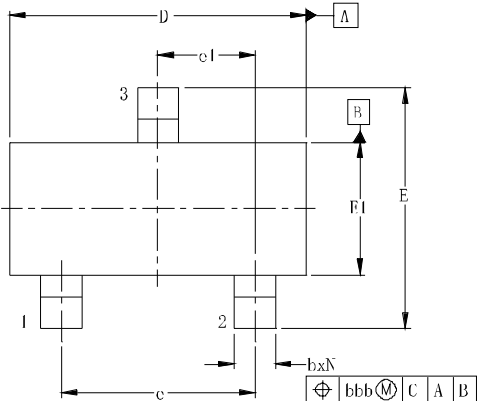

Suggested Land Pattern

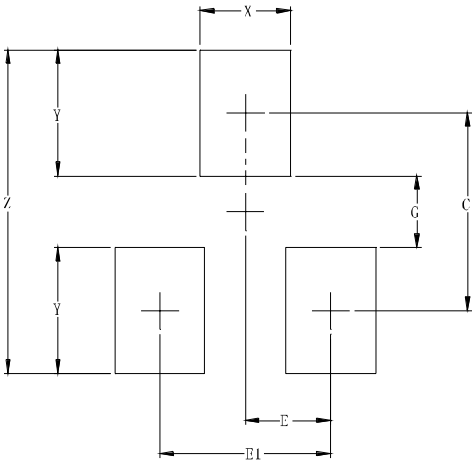

DIMENSIONS						
SYM	INCHES			MILLIMETERS		
	MIN	NOM	MAX	MIN	NOM	MAX
A	0.035	-	0.044	0.89	-	1.12
A1	0.000	-	0.004	0.01	-	0.10
A2	0.035	0.037	0.040	0.88	0.95	1.02
b	0.012	-	0.020	0.30	-	0.51
c	0.003	-	0.007	0.08	-	0.18
D	0.110	0.114	0.120	2.80	2.90	3.04
E	0.082	0.093	0.104	2.10	2.37	2.64
E1	0.047	0.051	0.055	1.20	1.30	1.40
e	0.075			1.90BSC		
e1	0.037			0.95BSC		
L	0.015	0.020	0.024	0.40	0.50	0.60
L1	0.022			0.55		
N	3			3		
ϕ	0°	-	8°	0°	-	8°
aaa	0.004			0.10		
bbb	0.008			0.20		

DIMENSIONS		
SYM	INCHES	MILLIMETERS
C	0.087	2.20
E	0.037	0.95
E1	0.075	1.90
G	0.031	0.80
X	0.039	1.00
Y	0.055	1.40
Z	0.141	3.60